



بِسْمِ اللَّهِ الرَّحْمَنِ الرَّحِيمِ

The image displays the Basmala in a stylized, bold Arabic calligraphic font. The text is written in black ink on a white background. Five long, vertical arrows point upwards from the top of the calligraphy, indicating the direction of the main strokes. Small numbers (1, 2, 3) and arrows are placed at various points along the letters to show the specific sequence and direction of the pen strokes used to form each character. The calligraphy is enclosed within a simple blue rectangular border.

• •

• • • • • • • • • •

• • • • • • • • • •

• • • •

• // • // • • • • • •

• • • • • // • //

• • • • • • • • • •

•••

• • // • • // • • • •

! • ! • • • • &

• • • • • • • • • •

•••

••• • • • • • • • • •

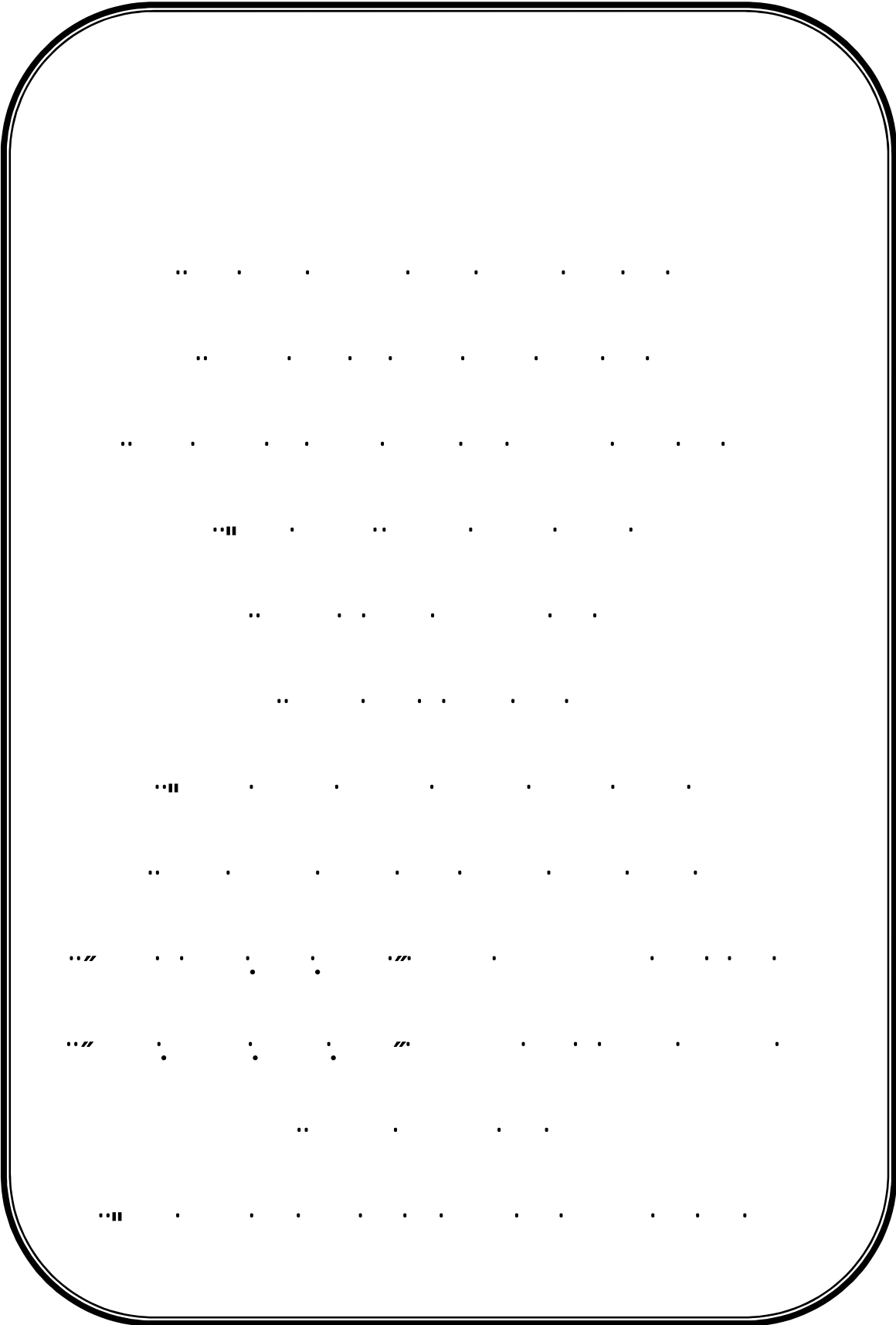



**Abstract :**

The small investment projects are the most important tools that contribute to economic development. It is also the primary engine of economic growth by improving the standard of living and improving income, Since the development reached by the developed countries and check him of economic growth, making the developing countries realize that the only way for economic development is the establishment of investment projects and the exploitation of its wealth best.

The feasibility study is one of the important tools that contribute to the rationalization of investment decisions and the financing of these projects, this study shed light on the subject in order to find out the extent of its contribution to the grant funding for small investment projects at the level of the National Agency for supporting youth employment –Mila Agency-. highlighting the importance of the feasibility study on the success of these projects, as it shows us the results of this study that the Agency's funding under consideration depends only on the part of financial feasibility study, while it turns out that there is a strong link between the study Project feasibility and success rates of small investment projects.

**Key words:** economic feasibility study, small investment projects, the funding decision.

- I ..... ..
- II ..... ..
- III ..... ..
- IV ..... ..
- V-VII ..... ..
- VIII ..... .. ù
- IX ..... .. ù
- X ..... ..

..... òò · ò ò ..

- ..... ..
- ..... ..
- ..... .. òò
- ..... .. òò
- ..... .. òò
- ..... .. ò
- ..... .. ò
- ..... .. òò
- ..... .. òò
- ..... .. òò
- ..... .. òò
- ..... .. ù òò

..... .ø ø

- 2 ..... ..
- ..... .. ø
- 3 ..... .. ø ò
- ) ..... ..
- , ..... ..
- %"\$ " ù ..... .. ù
- %"t ..... .. ù òò
- %"t ..... .. ø ò





· · · · ·	· · · · ·	· · · · ·
· · · · ·	· · · · ·	· · · · ·
· · · · ·	· · · · ·	· · · · ·
· · · · ·	· · · · ·	· · · · ·
· · · · ·	· · · · ·	· · · · ·
· · · · ·	· · · · ·	· · · · ·
· · · · ·	· · · · ·	· · · · ·

••Ø •

••	••Ø •	Ø •
7	• • • •	01
24	• •	02
69	• • • • Ø	03
87	• • • • •	04
105	• • • (ANSEJ) • • •	05
108	Ø • Ø • • •	06

	∅	∅
7		01
8		02
25	∅	03
27		04
31		05
38	∅ ∅	06
43		07
46	∅	08
48		09
52	∅	10
53		11
56	∅	12
57	∅	13
59		14
61		15
62		16
65	∅	17
81	∅	18
85		19
93	- ∅ ∅ ∅	20
95	∅ ∅ ∅ ∅	21
98	(ANSEJ) ∅ ∅ ∅ ∅	22

.. .

	.. .	..
<b>123</b>	(ANSEJ)Ø .. . . Ø . .	<b>01</b>
<b>125</b>	(ANSEJ) . . . . .	<b>02</b>
<b>126</b>	Ø . . . .	<b>03</b>
<b>127</b>	. . . . .	<b>04</b>
<b>128</b>	. . . .	<b>05</b>
<b>129</b>	. . . .	<b>06</b>
<b>130</b>	(VAN) . . . . Ø .	<b>07</b>

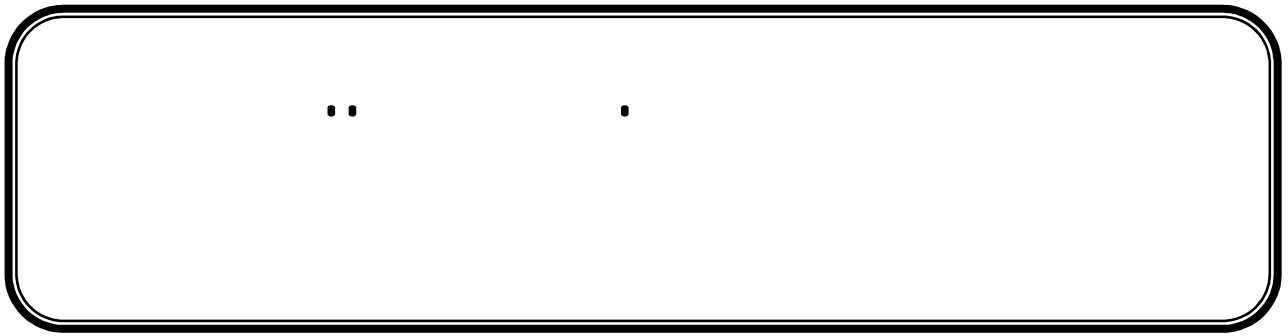





õ õ . . . . . 4

1 ù

õ ùõ õ ù . . . . . 5

"

.. . . . . **ô**

õ . . . . .

õ õ ù . . . . .

õ õ . . . . .

""

õ õ ù . . . . .

õ õ õ õ ù . . . . .

õ ù . . . . .

õ ù . . . . .

"

ù

.. . . . . **ô**

! õ õ! ù . . . . .                      .1

õ ù . . . . .

õ õ . . . . .

"

.. . . . .                      .2

" &\$% ù

õ . . . . .                      .3

! õ ! ù . . . . . ù

""

.. . . . . **ô**

ù                      .1



• Õ Ù ..... -  
1

• Õ Ù ..... -  
1

• Õ Õ Ù ..... Ù ..... -  
• Õ ..... Ù .....  
"

• Ù ..... .2  
"1 ..... Ù ..... !  
"fl ..... !

• ..... : Ô  
1 ..... -

" Ù ..... Ù ..... -  
..... : Ô

• Õ Õ .....  
• Õ Õ .....  
• Ù ..... Ù ..... Ù .....  
• Ù .....  
"

• Õ Õ Õ .....  
• Õ .....  
• Õ Õ Õ Õ Ù .....  
• Õ ..... Ù .....  
"

..... : Ô  
.....  
..... Ù .....



Õ “HYDRO MRBAINE”

Õ · Õ “&\$\$\*”

Õ · Õ · Õ

Õ · · · · · Õ -

Õ · Õ · Õ

1

Õ · · · · · Õ -

1Û

”

· Ø · · · · · Õ

· Õ · · · · · ·····

” Õ Õ · · · · · Õ

Õ · · · · · Ø Ø ·····

Õ Õ · · · · · Ø

Õ Õ · · · · · Õ

Õ · · · · · Õ Õ ·····

” · · · · · ! · ! · Õ · · · · ·

.Ù Ù

.

.

.

.

.

.

.

.





(1) ..... ù ..... -

1ù ..... ù -

1

" ..... ù ..... -

" ..... ù ..... -

õ ..... ù ù ..... -

(2)" ..... ù ù ..... -

ù ..... " ..... ù ..... -

(3)" ..... -

1 ..... ù ..... -

1 ..... ù ..... -

1 ..... -

1 ù ..... -

" ..... -

(4) ..... -

" ù ..... 1

Management) -

" ..... -

Man power) -

" ..... -

" ..... ù ..... materials) -

" ..... Machines) -

"% ..... ù ..... (1)

"\*( ..... &\$%& ..... (2)

"% + ..... &\$ - ..... (3)

15-13 ..... ! ..... &\$% ..... ù ..... (4)

" . . . . . fMarket) -

" . . . . . fMoneyL'Ù -

Ł . . . . . Ù . . . . . "&

"f| . . . . .

"f| . . . . . Ł . . . . . "

"f| . . . . . Ł . . . . . Ù . . . . . "(

"1 . . . . . Ù . . . . . ")

"f| . . . . . Ł . . . . . Ù . . . . . "\*

"1 . . . . . "+

.....

"1 . . . . .

Ł . . . . . ! -

"f|

---

(1) . . . . .

1 . . . . . Ù . . . . . Ù . . . . . -

1 . . . . . -

1 . . . . . -

1 . . . . . Ù . . . . . -

1 . . . . . Ù . . . . . Ù . . . . . -

1 . . . . . -

1 . . . . . -

1f| # Ł . . . . . Ù . . . . . -



Ø

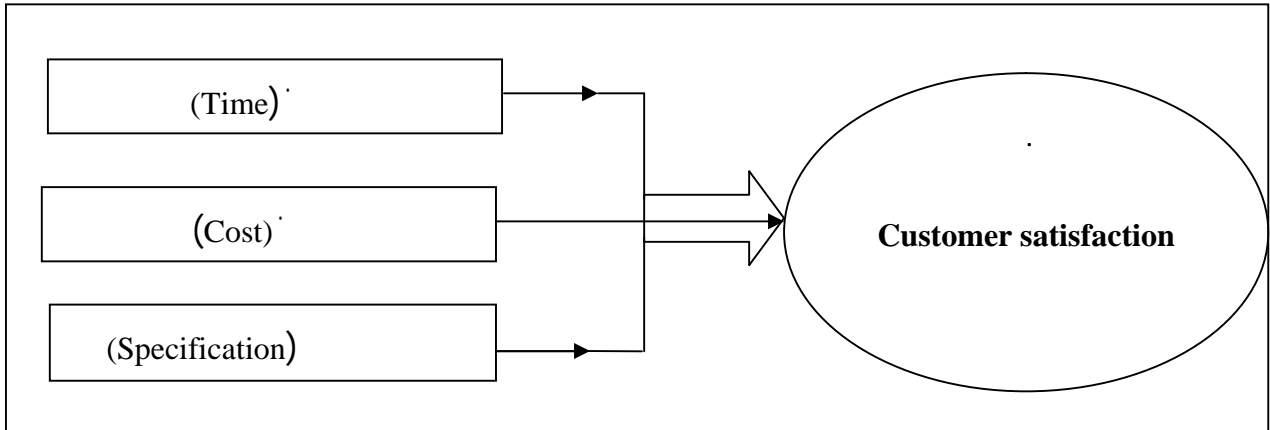

Ø

(1) Ø

Ø

Ø	Ø
Ø	Ø
Ø	Ø
Ø	Ø
Ø	Ø
Ø	Ø
Ø	Ø
Ø	Ø
Ø	Ø
Ø	Ø
Ø	Ø
Ø	Ø

Ø

∅ ∅

∅ ∅

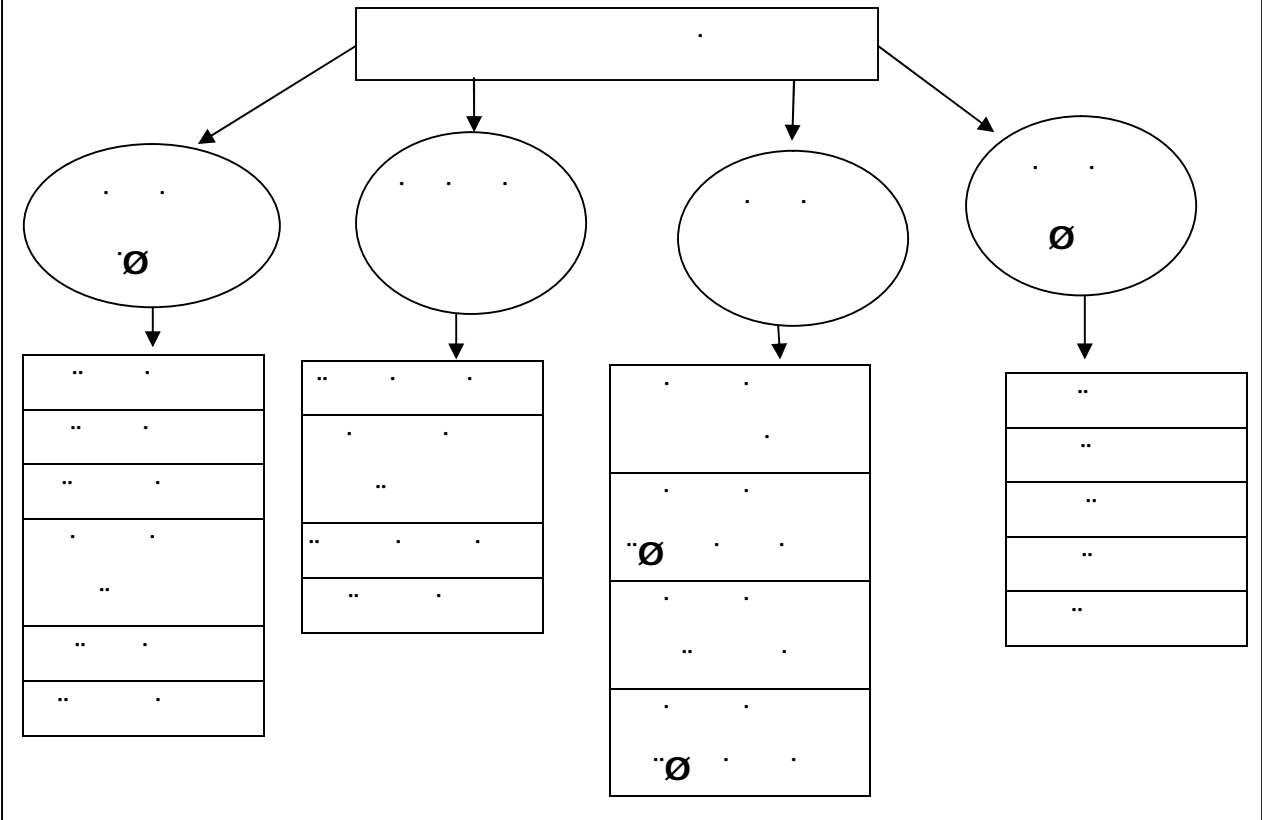

"%\*

∅

(1)

∅

∅

"1





(1)

Ù

(2)

Ù

1

1

1

Ù

1

Ù

"

Ù

Ù

Ù

!!!!

Ù

Ù

Ù

(3)"

Ø

Ø

\_\_\_\_\_

Ù

Ù

Ù

Ù

Ù

Ø

Ø

(4)

Ù

"1

!%

"" : Ù (1)

"" (2)

""&\$ (3)

""\*\*\*) (4)

٤' . . . Û . . . . . ' ! &  
"1fl "" " Û . . . . . Û . . .

:(Commercial Banks٤' ' !'

. . . . . Û . . . . .

. . . . . Û . . . . . (1)

. . . . . Û . . . . .

. . . . . Û . . . . .

. . . . . Û . . . . .

. Û . . . . . Û . . . . .

. . . . . Û Û Û . . . . .

(2)" . . . . .

. ∅ . . . . . ∅ . . . . . -

. . . . . Û . . . . .

(3)

. . . . . Û . . . . . •

. . . . . Û . . . . .

"1 . . . . .

"1 . . . . . •

Û . . . . . Û . . . . . •

"1 . . . . . Û . . . . .

" " . . . . . Û . . . . . •

Û . . . . . Û . . . . .

. . . . . Û . . . . .

Û Û . . . . . Û . . . . .

(4) . Û . . . . .

(1) MISHKIN Frederic, Monnaie, banque et marchés financiers, publié par Pearson éducation, paris, 9° édition, 2010, P : 17.

(2) سيد سالم عرفة، مرجع سبق ذكره، ص: 66.

(3) " + . . . . .

" - . . . . . Û . . . . . (4)



∅ ∅ !

Ù Ù

Ù Ù (1) Ù

Ù (2)

1

1

1

1

Ù

Ù

"

Ù

"

(3) Ù

"1 Ù Ù

Ù

Ù Ù Ù Ù

"1

Ù

Ù Ù

Ù

" Ù

""(\$: ... Ù ... (1)

""(%(\$: ... (2)

"(%: ... (3)

..... ∅ .....

Û Û  
Û Û  
" .....

..... ∅ !%

Û Û .....

(1)

"Û !

"1 !

"Û !

"1 !

"1 !

"1 !

" " !

Û Û ..... ∅ !

Û Û ..... (2) "

(3)

o ..... Û Û -

"1 ..... -

" Û Û -

Û ..... :\_\_\_\_\_ !

Û

(5)

Û

(4)

"") ! ( : ..... Û ..... (1)

" " ( : ..... (2)

" "% ( : ..... (3)

" " ( : ..... Û ..... (4)

" "% ( \* : ..... (5)



1

1

1

fl ĸ ∅ ! ô

1

(1)

(2)

(3)

(4)

(5)

(6)

(1)

(2)

(3)

(4)

(5)

(6)



\_\_\_\_\_!

(1) "

\_\_\_\_\_∅!&

Ù

(2) " Ù

(3) . Ù Ù Ù Ù

Ù

1 Ù

1 Ù

1

1

1 Ù

"

(4) . Ù

Ù Ù

1

1

1

"Ù

Ù

Ù

...."

" ) Ù (1)

"&% . (2)

" + \* (3)

"&%&& . (4)

Ø

!

Ù

!

Ù

..

Ù

Ù

..

..Ø

Ù

..

Feasibility study

Ù

Ù

(1)

Ù

Ù

Ù

Ù

Ù

..

(2)

..

(3)

..% ..&\$\$

(1)

..&% ..&\$\$%

(2)

.. ( ..&\$%

(3)



..... "..... ù -

..... ù.....

..... ù.....

..... ù..... ù.....

(1) ".....

..... ù..... -

..... ù..... ù.....

(2) ".....

..... ù..... ù..... "..... -

(3) ".....

..... "..... -

(4) ".....

.....

..... fl.....

..... fl.....

(5) ".....

.....

1.....

•

..... ù..... ù.....

•

1.....

.....

•

1.....

1..... ù..... ù.....

•

1.....

•

..... +..... &\$%\$..... (1)

..... \*..... +..... ù..... (2)

..... (3)

..... &&..... &\$-\$..... (4)

..... &&..... &%. (5)

..... (\$..... &\$%&..... &..... (5)



Ù · · · · · Ù · · · · · Ù · · · · · ·

1

Ù · · · · · Ù · · · · · ·

11

\_\_\_\_\_

(1) · · · · · Ù

\_\_\_\_\_ !%

£

fl

1

-

1

-

-

Ù

1

Ù

-

Ù

Ù · · · · · Ù · · · · · ·

1

1

·

·

1

Ù · · · · · Ù · · · · · ·

·

"

Ù : \_\_\_\_\_ !&

-

1

Ù

fl

£

\_\_\_\_\_ (1)



..... -

1                    ù

1

..... -

..... -

"

..... ù : \_\_\_\_\_ !'

1

ù

..... -

1

..... ù -

"

..... ! (

.....

.....

س

..... ù

س

س

.....

س

""

..... !)

ù

""

.....

..... ù

س

ù

س

..... ù

ù

(1)"

س

ù

..... ù

ù

""

ù

..... (1)

"" : \$\$\$\*



Ù

Ù

(1) Ù

1

Ù

Ù

Ù

Ù

Ù

Ù

Ù

Ù

(2) Ù

(3)

Ù

Ù

Ù

: \_\_\_\_\_

(4)

Ù

Ù

1

"(%. (1)

(2)

"% ,% ,&\$\$\* (3)

(4)

&\$% + \_\_\_\_\_

"&\$, :



Ù -  
"

\_\_\_\_\_

(1) Ù

Ù \_\_\_\_\_ Ù !%

Ù Ù

Ù

"" Ù

Ù \_\_\_\_\_ Ù !&

Ù

Ù Ù Ù

Ù

""

Ù \_\_\_\_\_ -3

""

\_\_\_\_\_ -4

Ù

Ù

""

: \_\_\_\_\_ -5

Ù Ù

Ù

Ù

"" Ù

(2)

"% \$,%+ : : &\$%& : : \_\_\_\_\_ (1)

"& : : &\$ \$, : : \_\_\_\_\_ Ù (2)



· ù · · · · · ù · · · · · ! \*

· · · · ·

! +

· ù

· ù

· ù

· ù

· ù

· · · · · ù

! ,

· ù

· ù

· ù

· · · · ·

(1)

1

1

· ù

· ù

1

1

· · · · ·

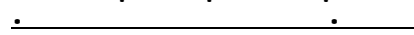

· ù

(1)

... f&L Ø

<p>1fl £ -</p> <p>... -</p>	
<p>1 -</p> <p>1 -</p> <p>1 -</p> <p>" -</p> <p>Ù</p> <p>Ù</p> <p>...</p>	
<p>1fl £ -</p> <p>...fl £ -</p>	

.)(!)\$ . ! &\$\$\*

Ø

Ø

Ù

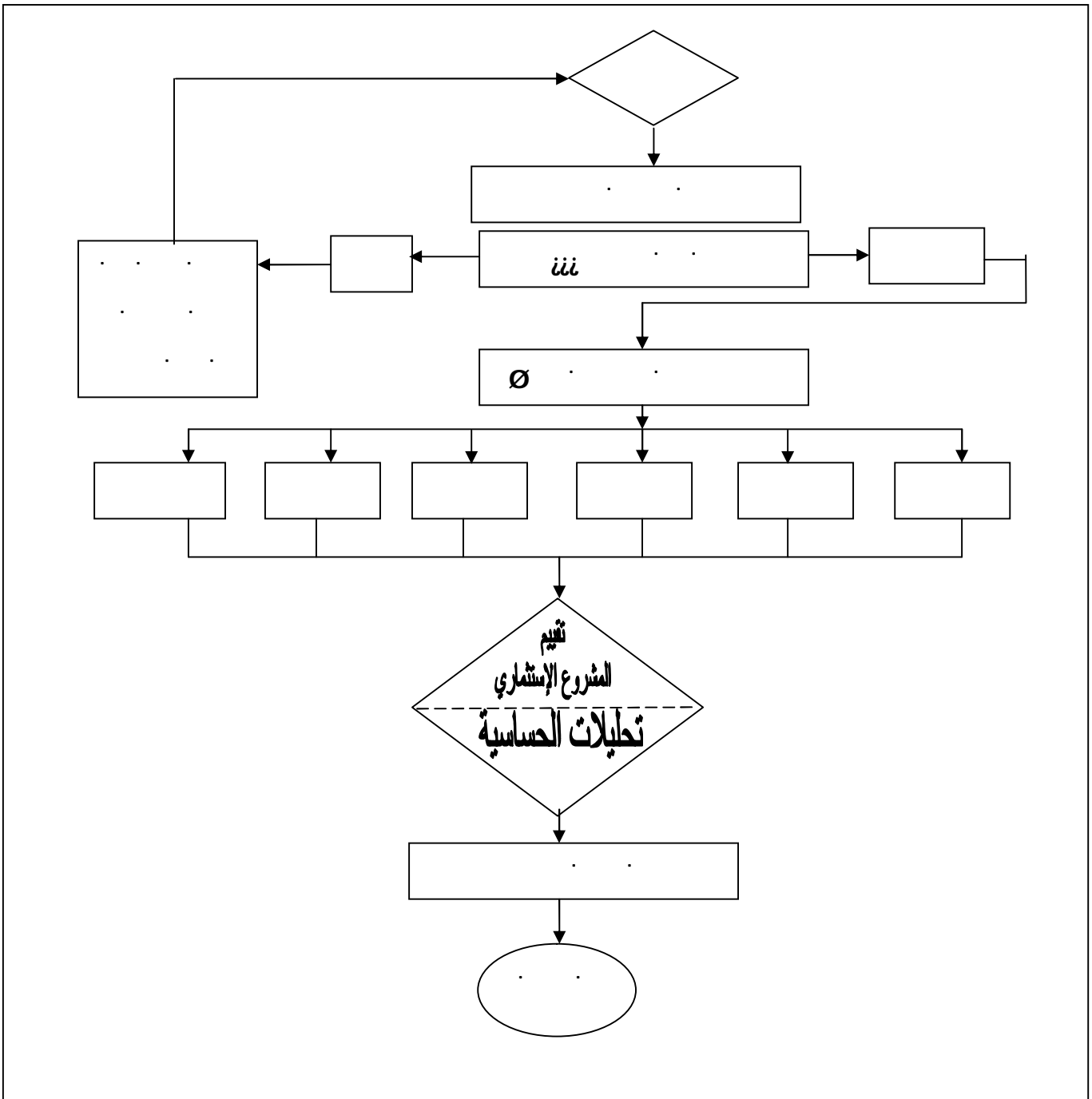

..... ) : ..... : \_\_\_\_\_

(1) .....

(2) .....

..... \* : ..... (1)  
 .....& : &\$%\$ : ..... (2)



1 . . . -  
 1 . . . -  
 1 . . . -  
 " . . . -

\_\_\_\_\_")

Û . . . Û . . .  
 . . .  
 . . . Û . . .  
 . . . Û . . .  
 (1) " . . .  
 : \_\_\_\_\_ :  
 . . . Û Û . . .  
 . . . Û Û . . .  
 . . . f(L ∅

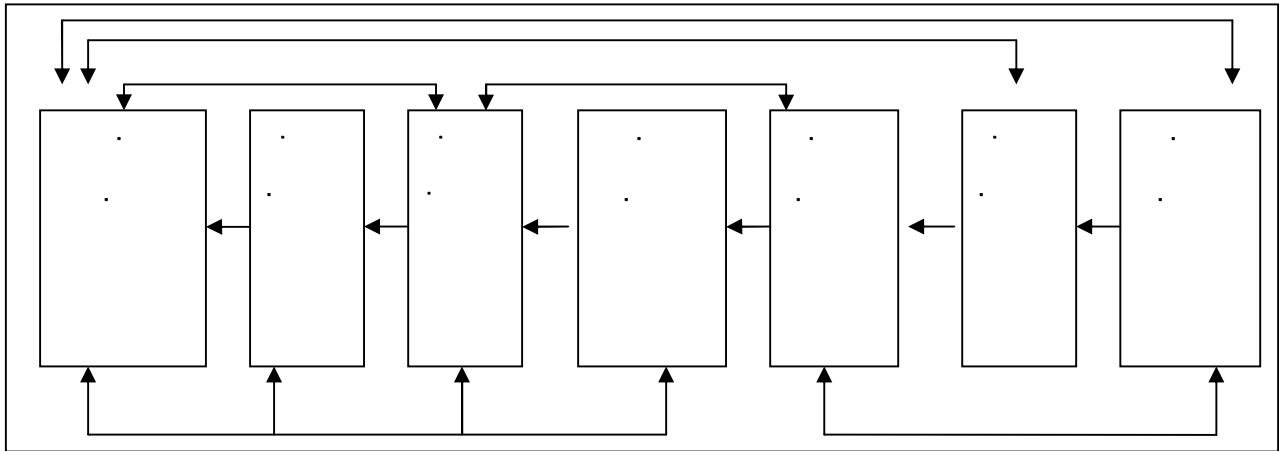

"(& . . . Û . . .

Û . . . Û . . .

(2) . . .

""&+ . . . (1)

""('(& . . . (2)



Û . . . . . " +

..

\_\_\_\_\_

Û . . . . .

(1) Û

\_\_\_\_\_ %

5

Û . . . . .

Û

Û

..

\_\_\_\_\_ &

Û

Û

1 -

1 -

1 -

" -

Û

Û

**(Replacement project) ∅** \_\_\_\_\_

Û . . . . .

..



: \_\_\_\_\_ Ù !

Ù .....  
د

د

د

o Ù Ù -

o Ù -

د

"" Ù

\_\_\_\_\_ Ù !

Ù Ù

د

""

\_\_\_\_\_ ""(

د

د

Ù

"" Ù

\_\_\_\_\_ ""

د

Ù

Ù

Ù

د

"" Ù

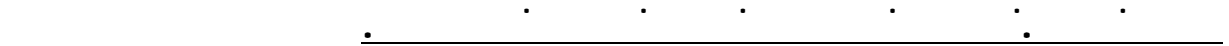

∅ ∅

∅

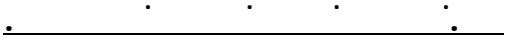

∅ ∅ ∅

(1)

∅ ∅

∅ ∅

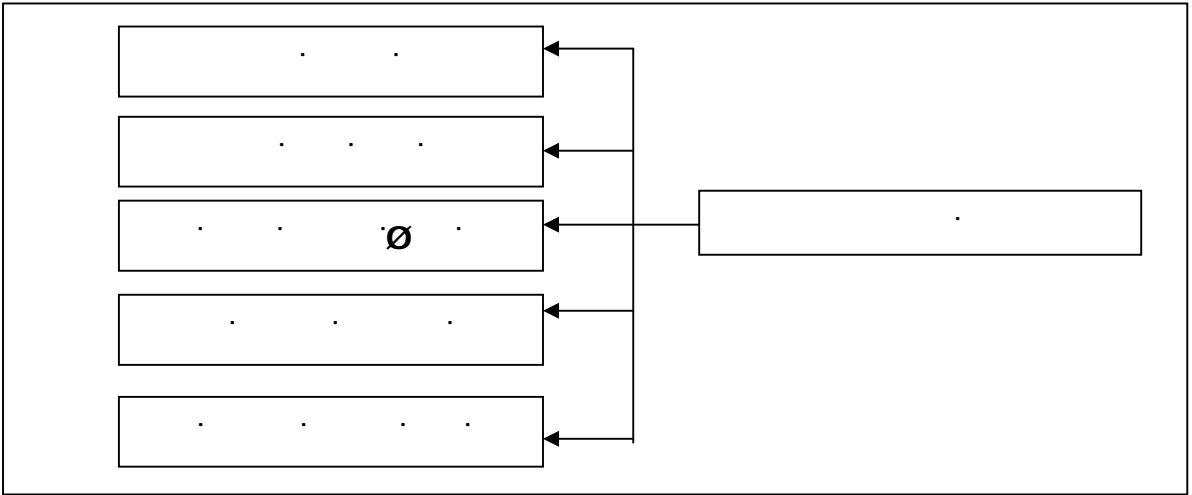

∅ ∅

(2)

∅

∅

∅



∅ ∅

∅

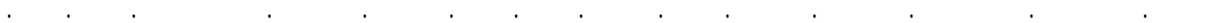

∅

∅ (1)

∅ (2)



∅

fl Ł

(1)

1

1

∅

Ù

(2)

1

Ù Ù

Ù Ù

Ù Ù

Ù

Ù

Ù

Ù

1

.45.

(1)

)\$(- : : : (2)



. . . . . Û . . . . . -  
 . . . . .  
 . . . . . " . . . . .  
 . . . . . Û . . . . .  
 . . . . . (1) . . . . .  
 . . . . . Û . . . . . -  
 . . . . . 1 . . . . .  
 . . . . . 1 . . . . . -  
 . . . . . 1 . . . . . Û . . . . . -  
 . . . . . " . . . . . -  
 . . . . .



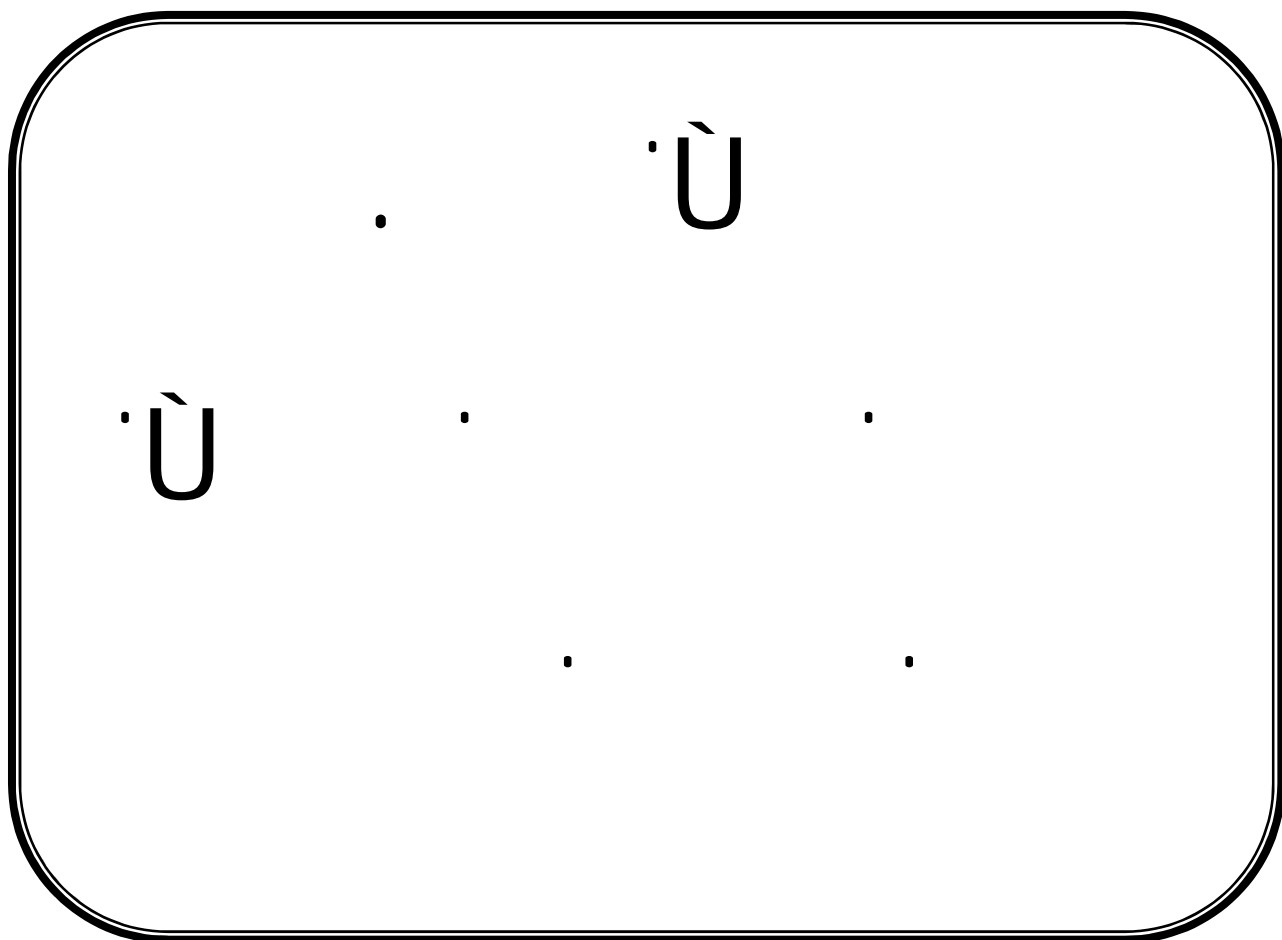



∅

∅

∅ ∅ ∅

∅

∅

∅

∅

∅

"

∅

-

"

-





Ù È . . . . .  
°f| Ù

Ù Ù  
Ù  
Ù  
Ù  
(1) "

---

(2)

1

1  
"

(3)  
Ù  
1  
"

---

Ù (1)  
""%+ : &\$% (2)  
""%&- : (3)  
""& : (3)

(1)

fl Ł -  
1  
1  
1  
Û  
Û Û  
fÛ Ł -  
1  
1  
fl Ł -  
""

---

(2)

.1  
Û  
""  
Û fl Ł Û .2  
Û fl Ł  
Û  
""  
.3  
""

---

""(&: &\$%\$&: (1)  
""(%(\$: (2)

(1)

Ù

Ù

1

Ù

Ù

Ù fl Ł

Ù

Ù

"

---

(2)

1

Ù

Ù

Ù

Ù

1

Ù

Ù

1

1

1

---

""(% . . . . . (1)

"" . . . . . (2)

.....

Ø

Ø

..... ù ..... -

1

ù ..... -

.....

''

.....

.....

(1)

1fl

£

-

1fl

£

-

1

-

..... ù ..... -

1

''

-

ù ..... ù ..... -

''

..... fHL Ø

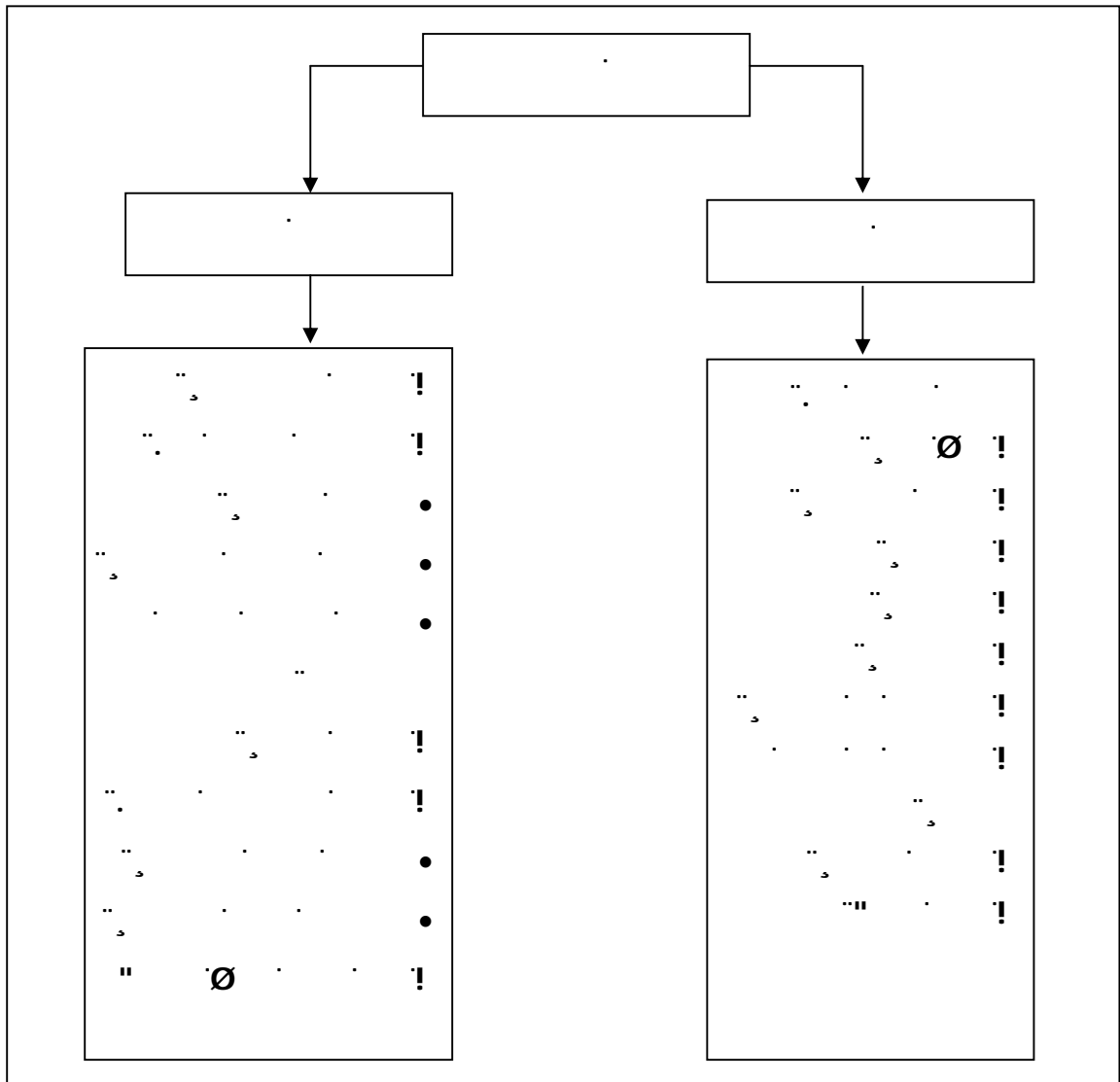

..... % %.

..... Û

i<sup>(1)</sup>

..... (2)

..... Û

..... -

..... -

..... -

..... % %.

..... % &.

..... (1)

..... (2)

..... ù ..... ù .....

ù (\*) ..... ù ..... ù ..... (1)»

(2)

1 ù

1

»

.....

ù

ù

ù

ù

..... ù

ù ù

ù

(3)»

..... ù

È

»»»»

ù

ù

»»»»

»%&

(1)

(2)

(3)



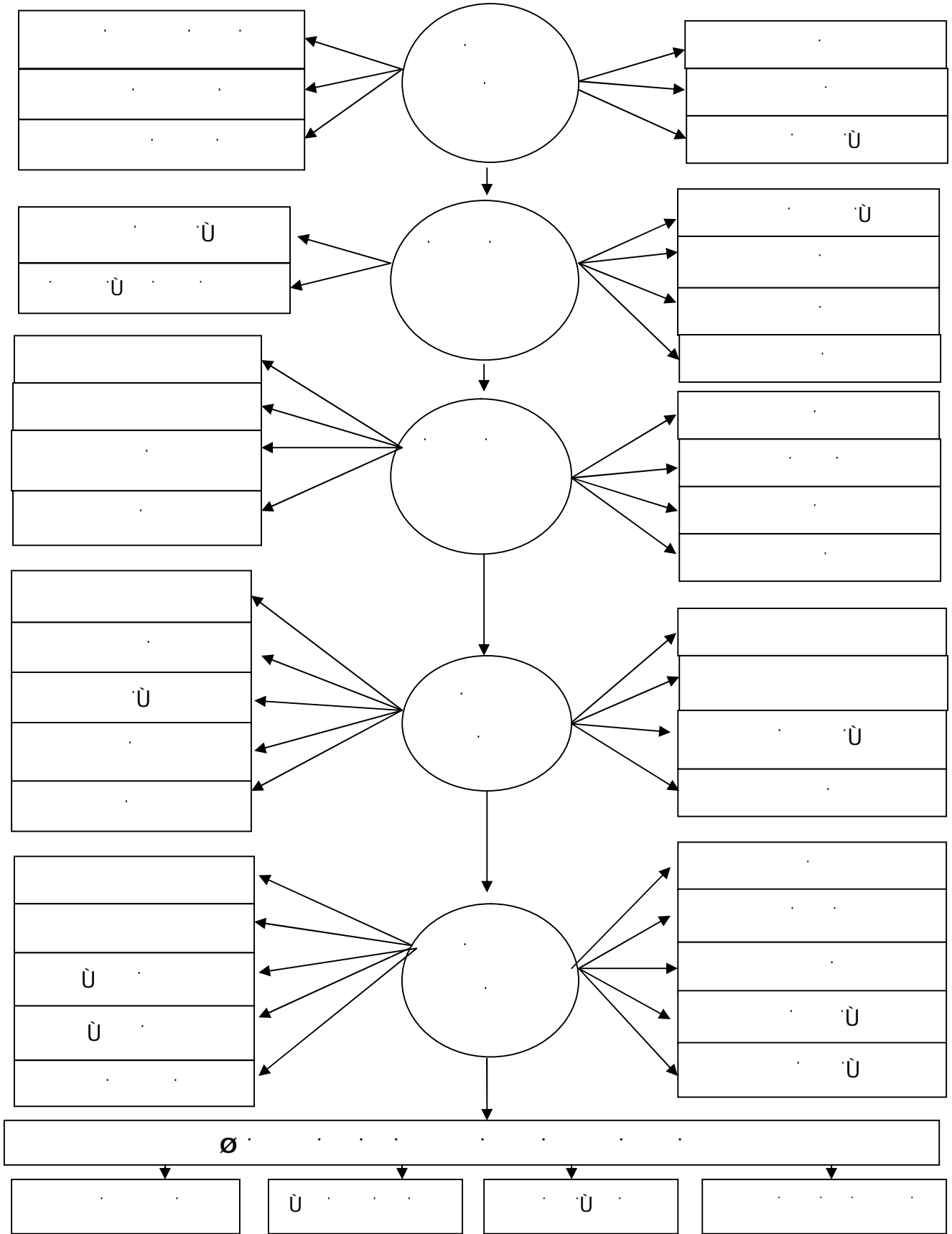

""&% :



∅

∅

∅

∅

∅ ∅

1

!

∅

∅

∅

∅

(2)

(1)

1

∅

∅

1

∅

∅

(3)

\_\_\_\_\_ •

||

\_\_\_\_\_ •

||

“( + : \_\_\_\_\_ (1)

\_\_\_\_\_ (2)

“( + : \_\_\_\_\_ (3)



\_\_\_\_\_

Ù Ù

Ù

Ù (1)

(2) " "

1 -

" Ù -

\_\_\_\_\_ .1

(3) Ù

: \_\_\_\_\_ !

: \_\_\_\_\_ -1!

.....

\_\_\_\_\_ ! &

Ù \_\_\_\_\_ -

Ù

""

Ù \_\_\_\_\_ !

Ù Ù Ù

""

""') : \_\_\_\_\_ (1)

""%& : \_\_\_\_\_ (2)

""') ( ) : \_\_\_\_\_ (3)

..... !

.....  
..... ù ..... ù .....  
..... ù ..... ù .....

..... Ø ..... 2

..... ù ..... ù .....  
..... ù ..... ù ..... ù .....

..... (1)..... ù .....  
..... (2) ..... ù .....

..... ù ..... !

..... ù ..... ù .....  
..... ù ..... ù .....

..... ù ..... !  
..... ù ..... !

..... ù ..... !

..... ù .....

..... ù .....

---

..... (1)  
..... (2)

..... ù . . . . .  
.....  
..... : \_\_\_\_\_ ! Õ  
..... ù . . . . .  
.....  
..... : \_\_\_\_\_ !  
.....  
..... : \_\_\_\_\_ -  
..... ù . . . . . ) \$  
..... "ù . . . . .  
..... ù . . . . . : \_\_\_\_\_ -  
.....  
..... " \_\_\_\_\_ Ø . . . . . 3  
..... ù . . . . . ù . . . . . ù . . . . .  
..... ù . . . . . ù . . . . .  
..... ù . . . . . ù . . . . . ù . . . . .  
..... (1) "

**: (Marketing feasibility study)**

..... ù . . . . .  
.....  
..... "ù . . . . .  
..... : \_\_\_\_\_ .....  
..... ù . . . . .  
.....

..... " % & . . . & \$ \$ , . . . . . ù . . . . . ù . . . . . (1)

Ù  
(1)»

ffi.

Ù

(2)»

Ù

Ù

Ø . f1\$E Ø

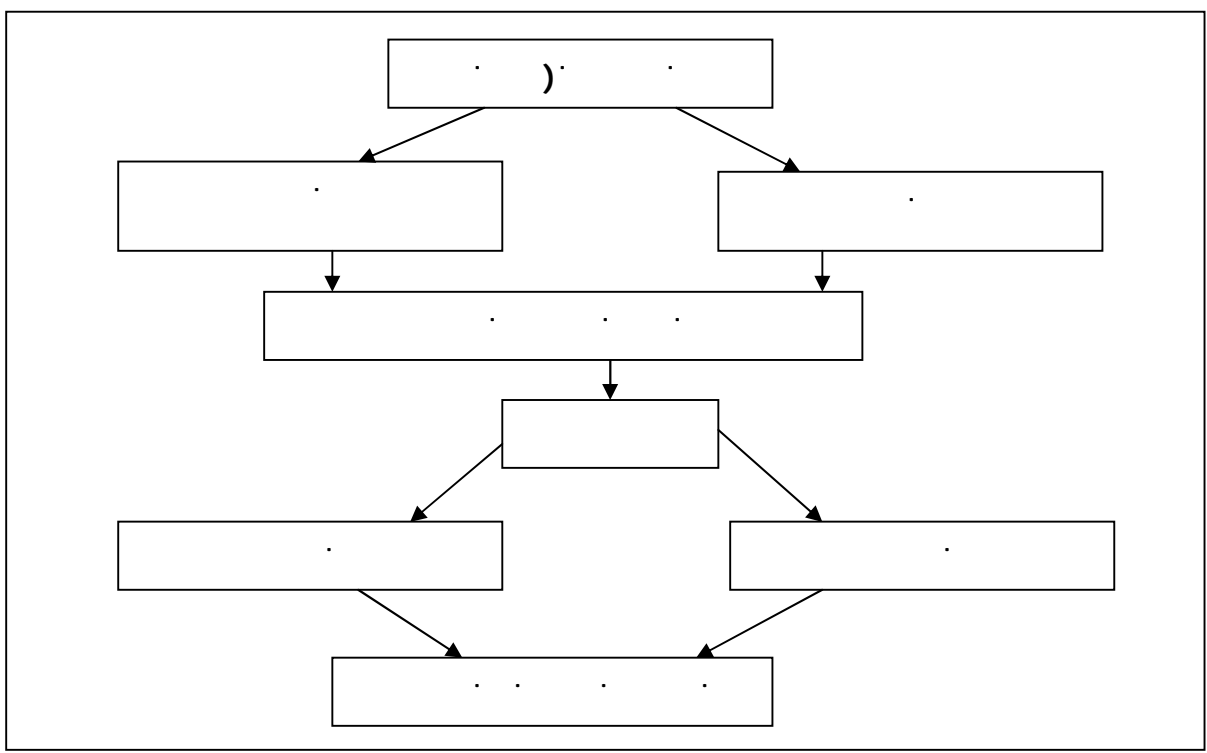

(3)

1

Ù

Ù

!  
!

- "" \$ . . . . . (1)
- "%" . . . . . (2)
- "" \$(-. . . . . (3)

1

"Ù

Ù

Ù

(1)"

Ù

Ù

Ù

(2)"

fl Ł

.fP%L' Ø

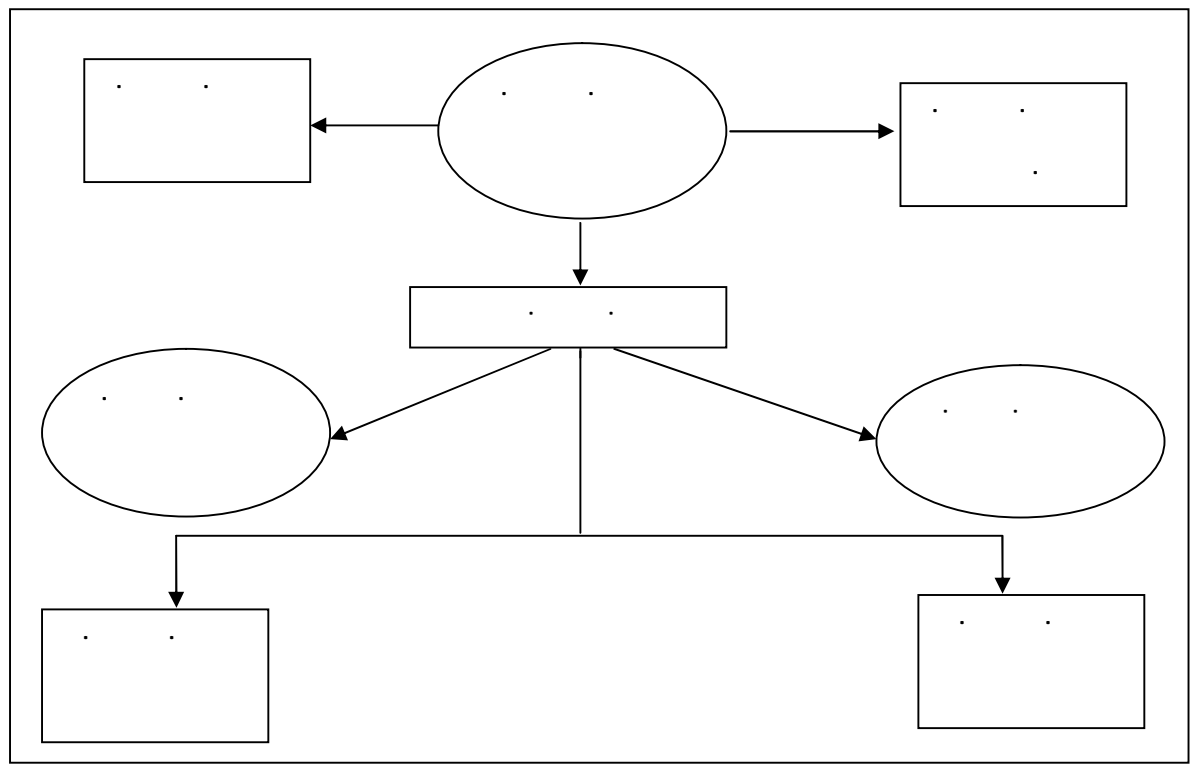

\*\$

"% %

(1)

"\* \$) -

(2)

(1) . . . . . Û . . . . .

. . . . . -  
1

1 . . . . . -  
Û . . . . . -

" . . . . .  
Û . . . . .

Û . . . . .

Û . . . . .  
Û . . . . .  
(2)" . . . . .

. . . . .  
Ø . . . . . %

Û . . . . . Û . . . . .

(3)" . . . . .  
(4) . . . . .

1 . . . . . Û . . . . .

" . . . . .

---

""% % % \$ . . . . . (1)

""% % . . . . . (2)

""(% &\$%\$ . . . . . (3)

Û . . . . . (4)

---

""(\* &\$% . . . . .

Ù . . . . .

(1) . . . . . Ù . . . . .  
.....  
..... Ù Ù

.....  
..... Ù . . . . .  
Ù . . . . .

.....  
..... Ù :Ø . . . . . !

.....  
..... Ù . . . . .

Ù . . . . .  
.....  
..... Ø .2

..... Ø !  
Ù . . . . .  
..... Ù Ù

---

"(, +(, . . . . . (1)

..

Ø

.fP&'L'

Ø

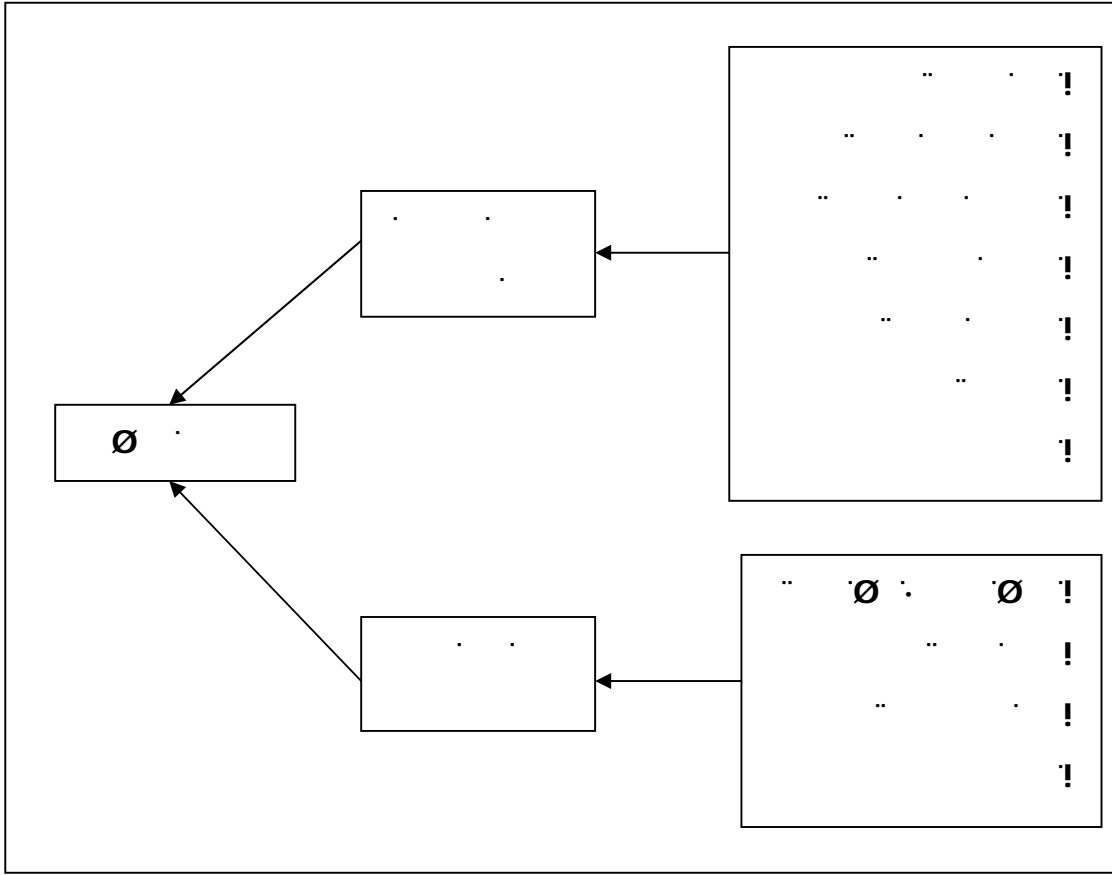

.."\$%&.

Ù

Ù

Ù

(1)

Ù

Ù

Ù

Ù

Ù

Ù

..

Ù Ø Ø -  
Ù  
Ù  
" !  
Ù !  
"1 .  
"1 Ù .  
1 .  
" " .  
Ø !  
Ù Ù  
" Ø % E Ø

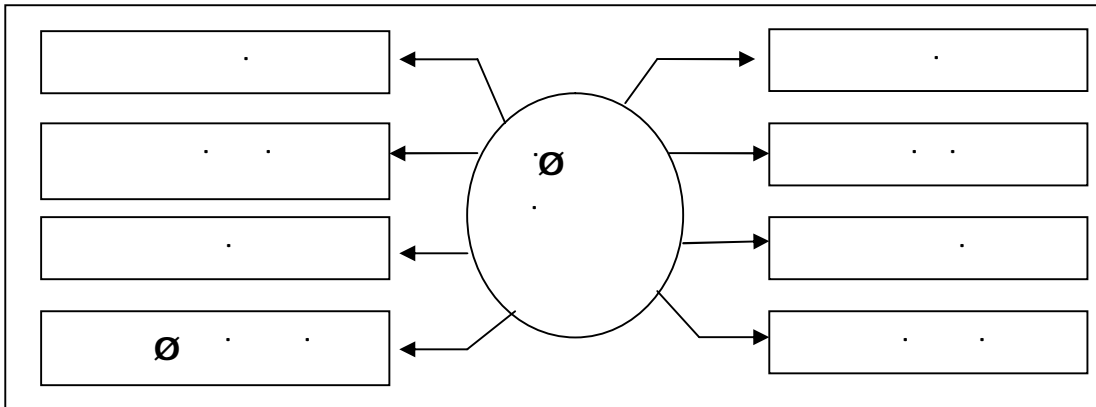

"(,+ :  
(1) Ù Ù Ù  
" !

..... Û ..... -

..... Û ..... -

..... " ..... -

..... " ..... -

..... Û ..... Ø ..... -

..... Û ..... -

..... " ..... -

..... " ..... -

..... Û ..... -

..... " ..... -

..... ..... .3

.....

..... Û ..... (1) ..

..... " ..... -

(2) ..

..... ..... (Secondary Data) ! ..

..... Û ..... Û ..... -

..... Û ..... -

(3) ..

.....

.....

(4) ..

Û

Û

1

-

..... " , + ..... (1)

..... "% ) ..... (2)

..... " ..... (3)

..... " , + ..... (4)

1 . . . . . -  
1 . . . . . -  
1 . . . . . -  
" . . . . . Ù . . . . . -  
Ù . . . . . Ù . . . . . -  
(1) . . . . . -  
1 . . . . . -  
1 . . . . . -  
" . . . . . -  
.....  
(2) . . . . . -  
..... ! . . . . . -  
Ù . . . . . -  
.....  
(3) . . . . . -  
..... Ø . . . . .

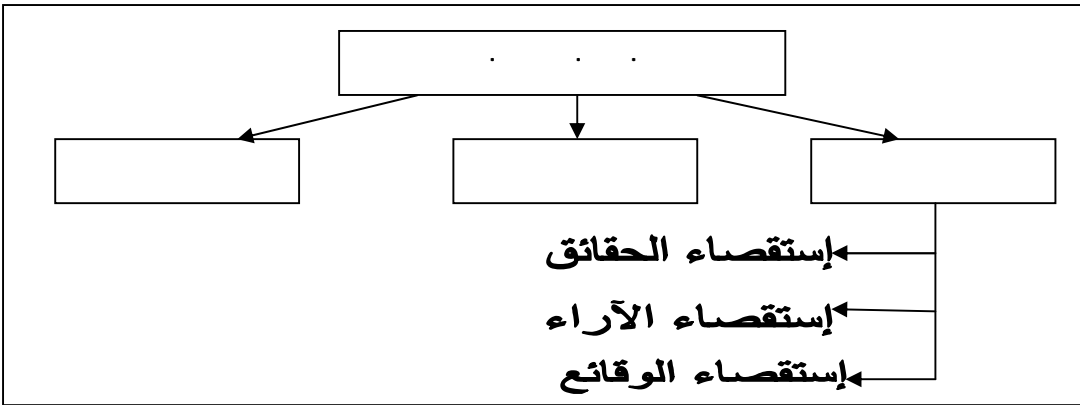

(Questionnaire) : .....

..... & ..... (1)  
..... \* ..... (2)  
..... & ..... (3)



(2)

(1)

**(Facts Questionnaire)**

Ù Ù

**:(Opinions Questionnaire)**

Ù

Ù Ù

Ù Ù

(3)

(4)

**.4**

Ù

Ù

Ù

Ù

- (1)
- (2)
- (3)
- (4)

..... : ۱۹۷ Ø

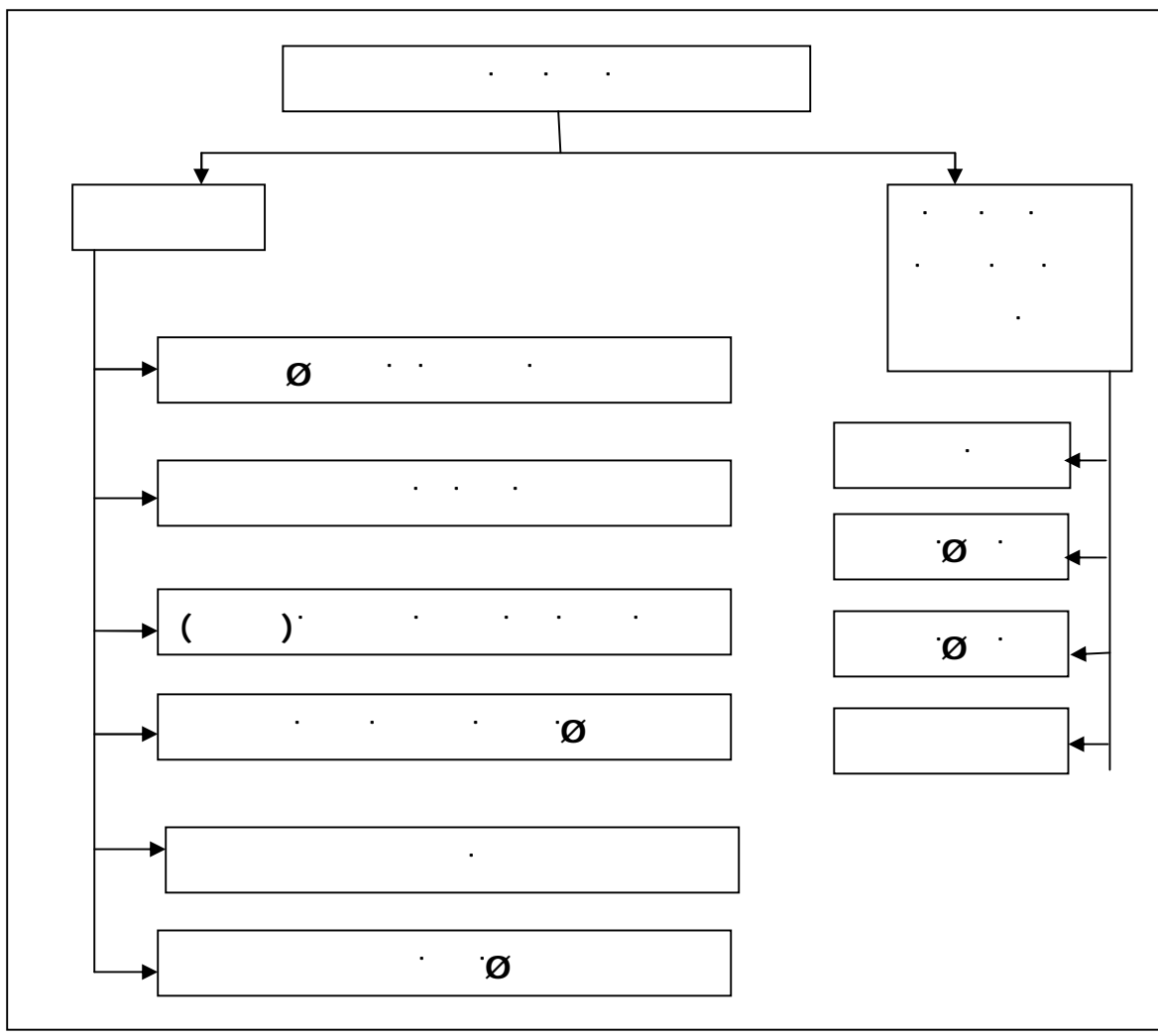

.....

..... Ø

..... -1

.....

(1) .....

..... Ø .....

..... -2

.....

Ù . . . . . fÙ . . . . . Ù . . . . . Ù . . . . .  
(1) fÙ . . . . . Ù . . . . .  
\_\_\_\_\_ .5

Ù . . . . . Ù . . . . .  
" . . . . . Ù . . . . .  
Ù . . . . . (2) . . . . .

" . . . . . f%Ù Ø

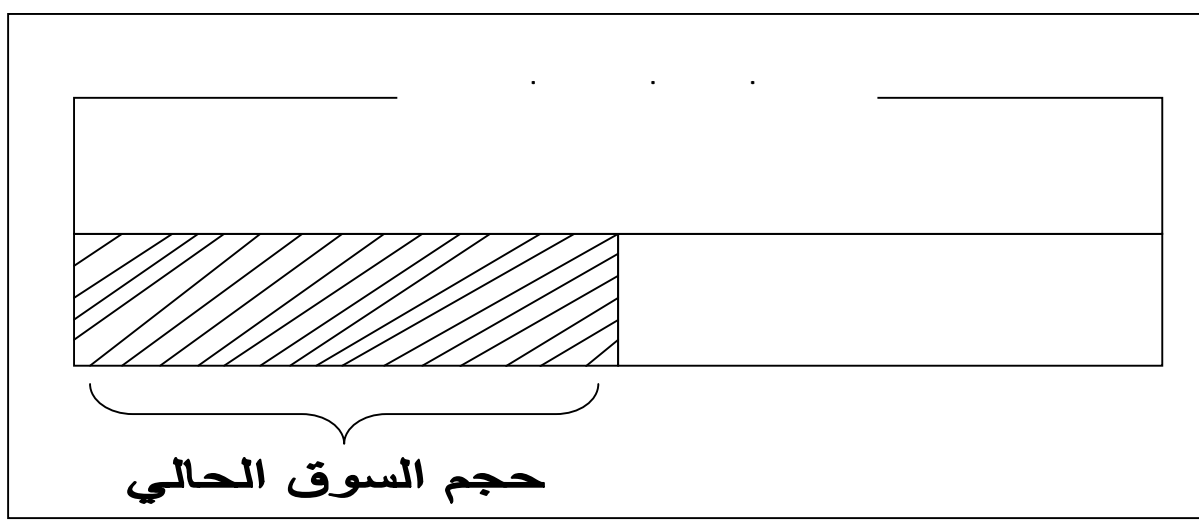

\*% . . . . .

(1) . . . . .  
(2) نور الدين زحوفي، مرجع سبق ذكره، ص: 61.

..... Ù .....  
 .....  
 ..... (1) .....

"fl Ł' .....	'1' .....
--------------	-----------

.....          .6

..... Ù .....

..... Ù .....

(2) .....

- °(Product pricingŁ' ..... -
- °(Promotional MeasuresŁ' ..... -
- .(Distribution systemŁ' ..... -
- !

Ù ..... Ù .....

..... Ù .....

..... Ù .....

..... ! Ù .....

..... Ù .....

..... (3) .....

- (4) .....
- 1 ..... -
  - 1 ..... -
  - 1 ..... -
  - 1 ..... -
  - " ..... -

..... (1) نور الدين زحوفي

..... (2) " & + .....

..... (3) " & ) , .....

..... (4) " & % & % % . . . . . & \$ % \$ ( Ù ..... Ù .....



Ù  
Ù  
fl  
Ù (1)  
Ù  
" . . . . . Ø . . . . . Ø (2)

... Ø . f%+L Ø

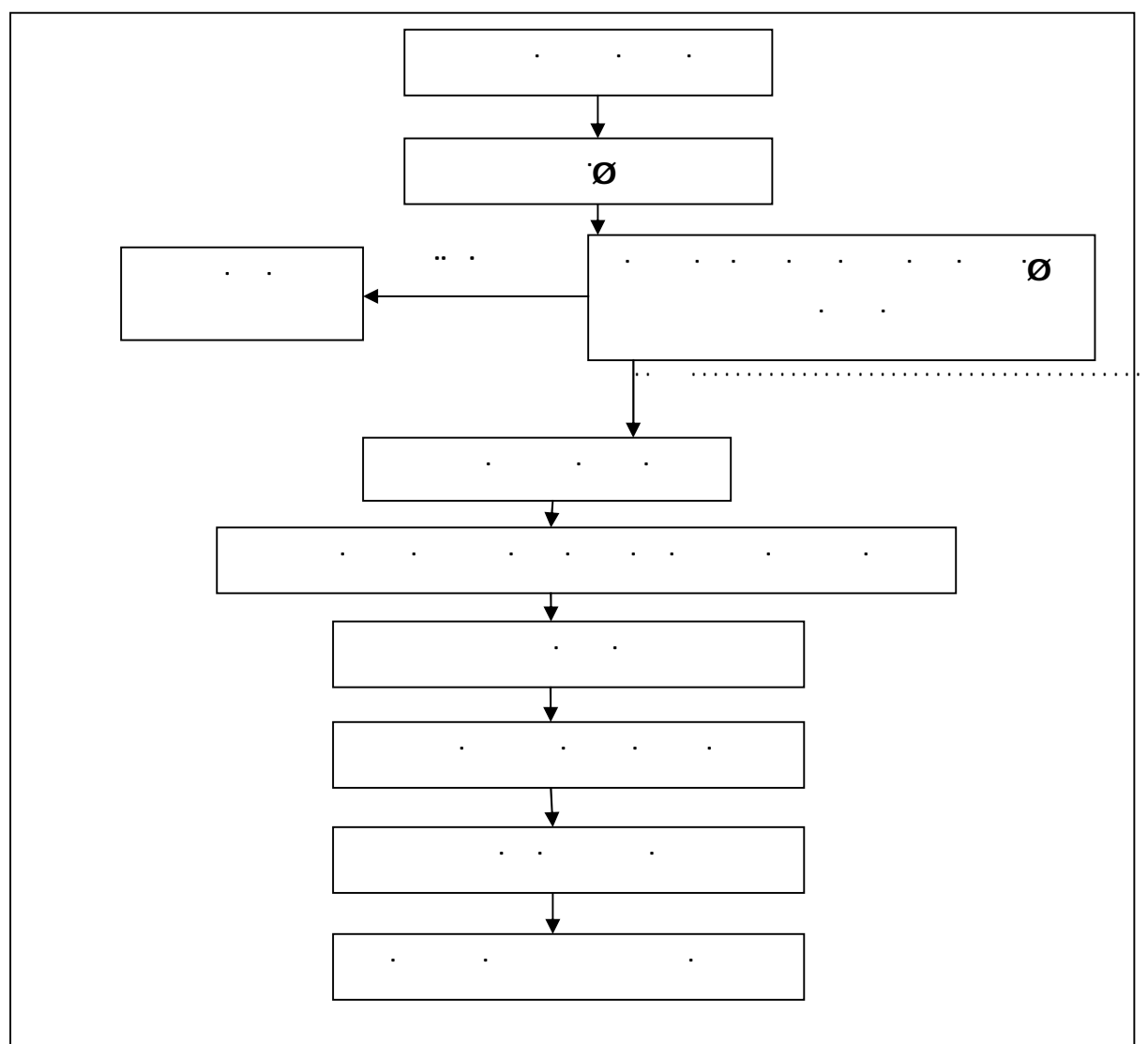

.\$\$. . . . .

...&+): . . . . . (1)

"".\$\$. . . . . (2)

\_\_\_\_\_ .1

Ù . . . . .  
 (1)Ù . . . . .  
 (2) . . . . .  
 1 . . . . . -  
 1 . . . . . -  
 Ù . . . . . Ù . . . . . -  
 1 . . . . . •  
 1 . . . . . •  
 1 . . . . . •  
 . . . . . •  
 . . . . .  
 . . . . . 1  
 " . . . . . •  
 . . . . .  
 . . . . .  
 . . . . .  
 "f| Ł . . . . .

	+	-	=	
..	.....	.....	.....	.....

Ù . . . . . Ù . . . . .  
 . . . . . "

"&+ . . . . . (1)

"%\$& . . . . . (2)

(1)''

(2)

1

1

1

"

.3

i<sup>(3)</sup> ù

(4)

(5)

1

1

ù

ù

ù

ù

1

ù

ù

1

ù

ù

ù

1

---

"& , . . . . . (1)

"" . . . . . (2)

"" \$' . . . . . (3)

"" / . . . . . (4)

""%\$- %\$, . . . . . (5)

Ù . . . . . -  
1 . . . . . -  
1 . . . . . -  
Ù . . . . . Ù . . . . . " . . . . .  
\_\_\_\_\_ .4

Ù " . . . . . Ù . . . . . (1)

:(capital Intensive TechnologyÙ \_\_\_\_\_ !  
Ù . . . . . Ù . . . . .  
Ù . . . . . Ù . . . . .  
" . . . . . Ù . . . . .

:(Labor Intensive TechnologyÙ \_\_\_\_\_ -  
Ù . . . . . Ù . . . . .  
Ù . . . . . Ù . . . . .  
Ù . . . . . Ù . . . . .  
" . . . . .

(2)  
Ù \_\_\_\_\_ :(continuous ProductionÙ \_\_\_\_\_ -  
\_\_\_\_\_ :(Production by BatchesÙ \_\_\_\_\_ -  
" . . . . .

---

"%&,%&&. . . . . (1)  
"%&,%%&. . . . . (2)

..... ù

..... 1 . . . . . •

..... " . . . . . •

..... .5

..... fl . . . . . Ł

..... ù

..... ù

..... ù

..... " . . . . .

..... (1)"

..... (2)

..... ù

..... ù

..... " . . . . . f\$, Ł

..... ù

..... ù

..... " . . . . . ù

..... " . . . . . Ø . fl Ł Ø

1 . . . . . -	1 . . . . . -
"1 !	"1 !
"1 !	" " !
"1 !	
" " !	

..... ù

..... ù

..... "()" : . &\$\$()

..... "%% : . . . . . (1)

..... " " . . . . . (2)

\_\_\_\_\_ .6

..... ù

..... ù ù

(1)

..... ù ù : \_\_\_\_\_ !

..... -

1 ..... ù ù

..... -

1 ..... ù

..... ù : \_\_\_\_\_ -

1 ..... ù

..... -

..... ù ù

..... !

..... ù

..... ù ù

1 ..... -

1 ..... -

1 ..... -

1 ..... -

1 ..... ù

..... ù ù

.....

\_\_\_\_\_ ! Ø Ø ! Ø

..... ù ù

..... ù

..... ù ù (1)



..... ù . . . . .  
 . . . . . ù . . . . . ù ù . . . . .  
 . . . . . ù . . . . . ù . . . . .  
 " . . . . . ù . . . . .  
 ù . . . . . ù . . . . .  
 ù . . . . . ù . . . . .

(1)"

(2)

1 ù . . . . . -  
 . . . . . ù . . . . . ù . . . . . -  
 1 ù . . . . . ù . . . . .  
 " . . . . . ù . . . . .

..... : òò

---

(3)

1 ù . . . . . -  
 1 . . . . . -  
 1 . . . . . ù . . . . . -  
 " . . . . . -

: Ø . . . . . 1

ù . . . . . ù . . . . . ù . . . . .  
 (4)" ù . . . . . ù . . . . .

.Ø . . . . . Ø . . . . . !

---

... . . . . . ù . . . . . ù . . . . . ù . . . . . ù . . . . .

---

"") : . . . . . ù (1)  
 ""\*)\*) : . . . . . (2)  
 ")\* : . . . . . (3)  
 "" , \$ : . . . . . (4)



1 . . . ù . . . . . •  
 ù . . . ù . . . . . •  
 " . . . . .

(1) . . . . .

ù . . . . . ù . . . :ù . . . . . •  
 . . . . . ù . . . . .  
 . . . . . ù . . . . .  
 (2)" . . . . .

ù . . . . . ù . . . . . •  
 ù È . . . . .  
 " . . . . . ù . . . . .

ù . . . . . ù ù . . . . . : . . . . . •  
 . . . . .  
 " . . . . .

(3) ù . . . . .  
 1 ù . . . ù . . . ù . . . ✓  
 " . . . . . ù . . . . . ✓

ù . . . . . ù . . . . .  
 ù . . . . .  
 " . . . . .

**:(Leasing** . . . . . -

ù . . . . . ù . . . . . ù . . . . .  
 ù . . . . .  
 (4)" . . . . .

---

""% %. . . . . (1)  
 "" \* . . . . . (2)  
 ""% & % % . . . . . (3)  
 "" - \$ . . . . . (4)



Ø

Ø

\_\_\_\_\_ .2

Ù

Ù

Ù

Ù

Ù

Ù

(1)»

Ù

\_\_\_\_\_ -

Ù

(2)»

Ù

360

\_\_\_\_\_ X

X

Ù

1

Ù

\_\_\_\_\_ -

(3)»

Ù

Ù

\_\_\_\_\_ Ø -

(4)

Ù

Ù

Ù

Ù

\_\_\_\_\_) (1)

(\$+,(\$\* (2)

""%&\* (3)

""\*\$!), ! (4)

.....  
..... 1 ..... Ø .....

..... ù .....

..... Ø ž ..... 1 ..... Ø .....

..... ù .....  
..... ù .....  
..... ù .....  
..... ✓

..... 1 ..... Ø .....

..... ù ..... •

..... Ø ž ..... 1 ..... Ø .....

..... Ø . Ø . -  
(1)

..... 1 ..... Ø .....

..... " \* & . . . . . ù . . . . . ù (1)

(1) . . . : Ø -

.. . . . 1 .

(2) . . . . . : Ø

( . / . ) + .  
 fl Ø !%x ..... 1 Ø .  
 ..... &#fl . Ž . . . )

..... ù . . . . . ù . . . . . ù . . . . .  
 . . . . . ù . . . . . ù . . . . . ù . . . . .  
 (3) "

. . . . . Ø . 3

..... ù . . . . . ù . . . . . ù . . . . .  
 . . . . . ù . . . . . ù . . . . . ù . . . . .  
 (4) ù . . . . . ù . . . . . ù . . . . .  
 . . . . . ù . . . . . ù . . . . . ù . . . . .  
 (5) . . . . . ù . . . . . ù . . . . .

..... ù . . . . . ù . . . . . ù . . . . .  
 (6) . . . . . ù . . . . . ù . . . . .  
 . . . . . ù . . . . . ù . . . . . ù . . . . .  
 . . . . . ù . . . . . ù . . . . . ù . . . . .  
 fù . . . . . Ł . . . . . ù . . . . .  
 1fù . . . . . Ł . . . . . ù . . . . .

- ("\$&: . . . . . (1)
- "(\$' : . . . . . (2)
- ""(\$, : . . . . . (3)
- "" \_ : . . . . . (4)
- ""\*! : . . . . . ù . . . . . (5)
- ""\* ( \*! : . . . . . (6)

..... ù ..... 1 ù -

..... 1 ..... -

..... ù ..... -

..... ù ù ..... 1 ..... -

..... ù ..... ù ..... 1 ù -

..... " ..... -

ù ..... ù ù ..... ù ..... (1) -

..... 1 ù ù ..... ù ..... -

..... ù ù ..... : ..... -

ù ..... 1 ..... ù ..... -

ù ..... ù ..... ù ..... -

..... ù ..... " ..... -

..... ù ..... " ..... -

..... (1) -

\_\_\_\_\_ .4

Ù . . . . . Ù

.....

(2) . . . . . (1)

..... :Ø \_\_\_\_\_ !

Ù

"1 . . . . . -

"1 . . . . . Ù -

"1 . . . . . Ù -

"1 . . . . . Ù -

"1 . . . . . -

"1 . . . . . -

"1000 . . . . . Ù . . . . . -

" . . . . . -

..... : \_\_\_\_\_ !

..... " . . . . .

"1 . . . . . -

"1 . . . . . Ù -

"1 . . . . . -

"1 . . . . . -

"1 . . . . . -

"1 . . . . . -

"1 . . . . . -

"1 . . . . . -

" . . . . . -

..... : \_\_\_\_\_ !

.....

\*\*\*+ . . . . . Ù . . . . . (1)

"% \* %) . . . . . (2)

"1fl Ț . . . . . -  
"1fl Ț . . . . . -  
"" . . . . . -

. . . . .  
. . . . .

(1)" . . . . .

(2) . . . . .

. . . . .  
1 . . . . . Û . . . . . -

Û . . . . . -  
1 . . . . .

" Û . . . . . -  
. . . . .

\_\_\_\_\_ . . . . .  
\_\_\_\_\_ . . . . .

. . . . . Û Û . . . . .  
. . . . . "" . . . . .

Û . . . . . Û . . . . .  
Û . . . . . Û . . . . .

. . . . . Û . . . . .

""% + . . . . . (1)  
" . . . . . (2)

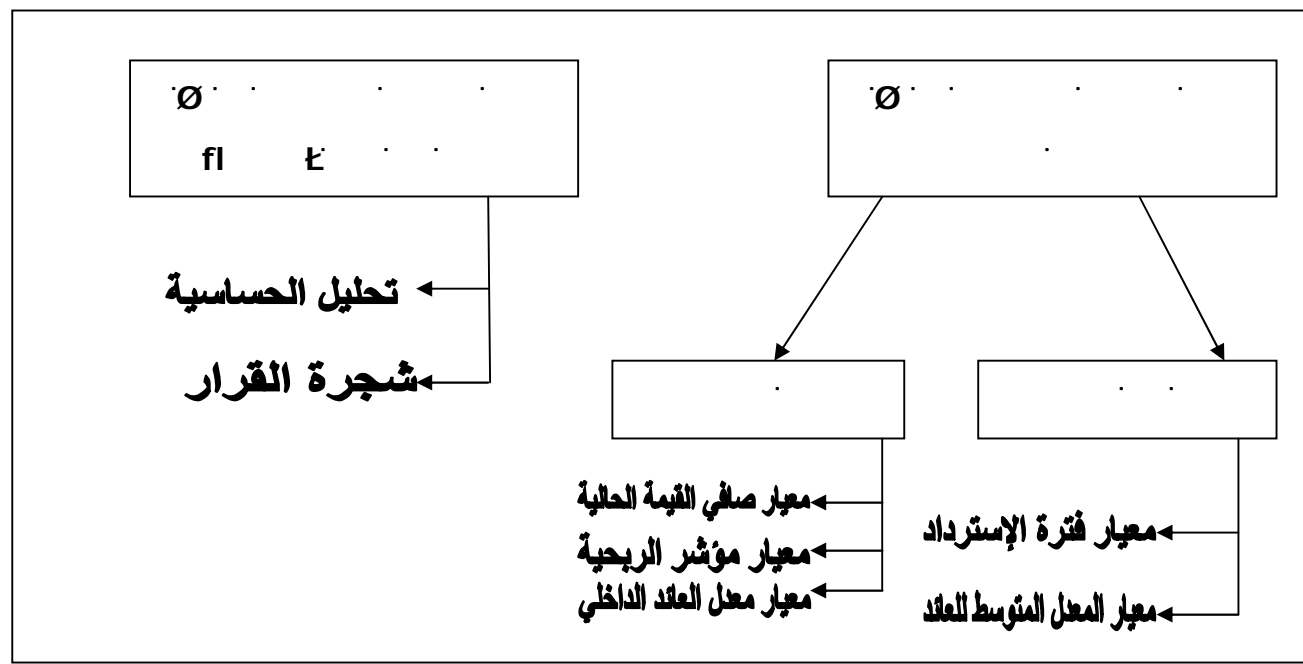

..... ! . . . . . % % % %

**1. Pay Back Period :**

.....  
.....  
.....

(1) ..

(2) ..

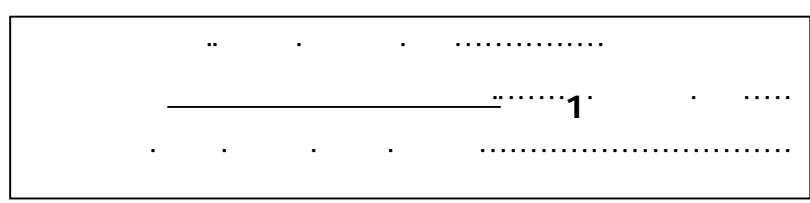

(3) ..

..... (1)

..... (2)

..... (3)

$$\frac{U_1}{1+i} + \frac{U_2}{(1+i)^2} + \dots + \frac{U_n}{(1+i)^n} = \dots$$

" (1)

$$1 \cdot \frac{U_1}{1+i} + \dots + \frac{U_n}{1+i} = \dots$$

**:(Average Rate of Return) Ø .2**

(3) (2)



U

U

U

" U U U

U

(4) U fU U U E

**:(Net Present Value) .3**

fNPV

U

"% (,%' : .. (1)

"% & : .. (2)

"% (\*,%( ) : .. (3)

" : .. (\*)

"% : .. (4)

$$NPV = \sum_{t=1}^T \frac{F_t}{(1+K)^t} - I_0 \quad (1)$$

(3)

$$= \sum_{t=1}^T \frac{F_t}{(1+K)^t} - I_0$$

(4)

$$= \sum_{t=1}^T \frac{F_t}{(1+K)^t} - I_0$$

**:(Profitability index) 4**

(5)

$$PI = \frac{\sum_{t=1}^T \frac{F_t}{(1+K)^t}}{I_0}$$

- (1)
- (2)
- (3)
- (4)
- (5)

1

(1) " Û Û Û

**5. (Internal rate of return) Ø**

Û

Û Û

Û Û Û

" Û

(3) (2)

Û Û Û Û -

1

Û Û Û -

"

(4) Û

x fl Ø Ø )
" Ø
----- Ø 1 Ø
صافي القيمة الحالية للتدفقات النقدية عن معدل الخصم الأصغر - صافي القيمة الحالية للتدفقات النقدية عن معدل الخصم الأكبر

Û

(5) Û Û

(6)

1 -

" Û -

- (1) "Ø - %"
- (2) "(((
- (3) "
- (4) "Ø +
- (5) "(( +
- (6) "Ø ,

6. (Sensitivity Analysis)

(1)

(2)

1 -

1 -

1 -

" 0 -

7.

(3)

0

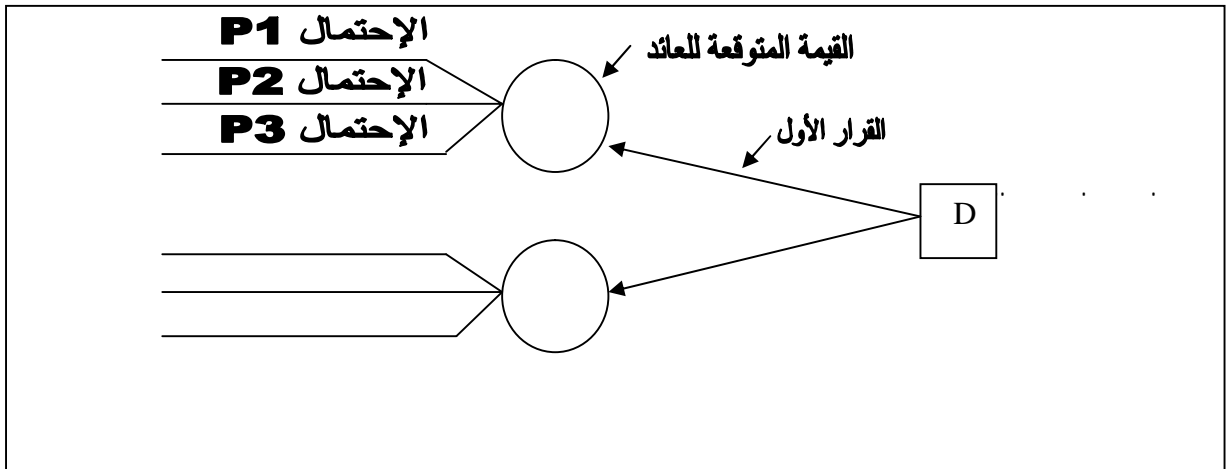

0

!

0 0 0

(1)

(2)

(3)

Ù  
(1) ..  
..... : 00

(2) ..  
Ù Ù Ù  
Ù  
Ù

(3) .. Ù Ù

(4) ..  
1fl È Ù -  
1 -  
1Ù -  
1fl È -  
Ù -  
..... : 0

Ù Ù

""%(\$: (1)

""(+%. (2)

Ù (\*)

"" )&. (3)

""(+++. (4)



	..	.3
	1	-
	1	-
! % ! % \$		-
Ø Ø		.4
	"	.5
	"	.6
	..	.7
	1	-
	..	-

..Ø

Ù

Ù Ù

..

Ù

"1

س

س

س

Ù

"1

Ù

"1

Ù

"

Ù

..

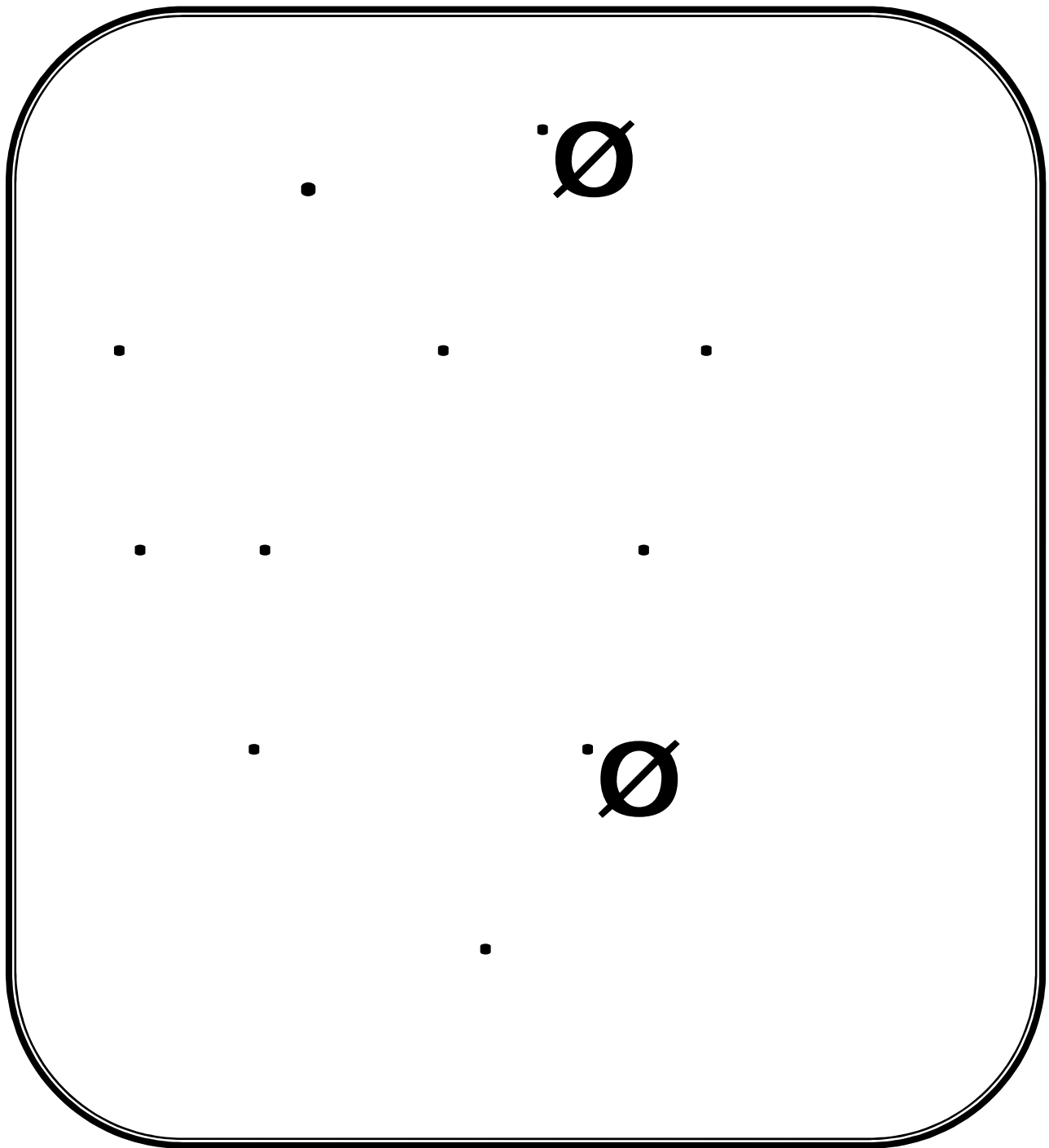

Ù

Ù



..

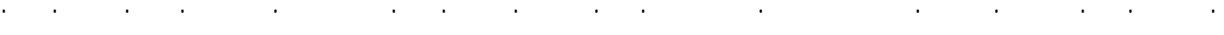

Ù

Ù



Ù

Ù

Ù



..



Ù

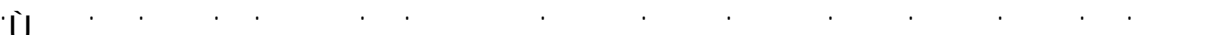

Ù

..



..

!

Ø

..

..Ø

-



Ø

..

-

..



" ! Ø f&S Ø

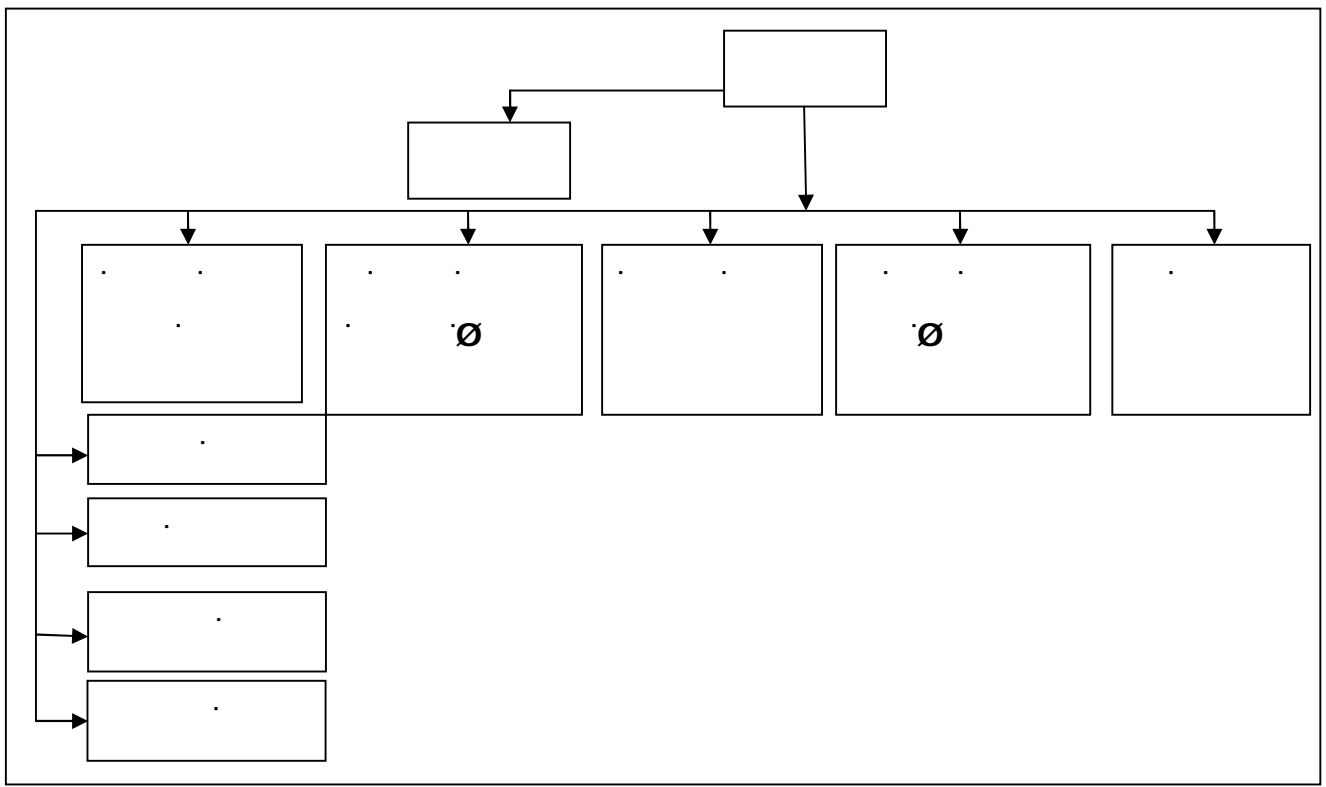

" Ø

(1) Ø

1	Ø	1	-
Ø	Ø	Ø	-
1	Ø	1	-
Ø	Ø	Ø	-
1	Ø	1	-
Ø	Ø	Ø	-
1	Ø	1	-
Ø	Ø	Ø	-

1

" Ø (1)

..... ù ..... : ù

---

..... -  
" ..... ù

(1) ..... ù

..... -  
1 ù  
1 ..... -

ù ..... ù -  
" ù ..... ù

..... ø ø :  
\_\_\_\_\_

..... ø ø :  
\_\_\_\_\_

ù ..... ù ..... ù .....  
" ..... ù ù

..... ù ..... (1)

U U  
 " Ø . . . . . Ø Ø .f&% Ø

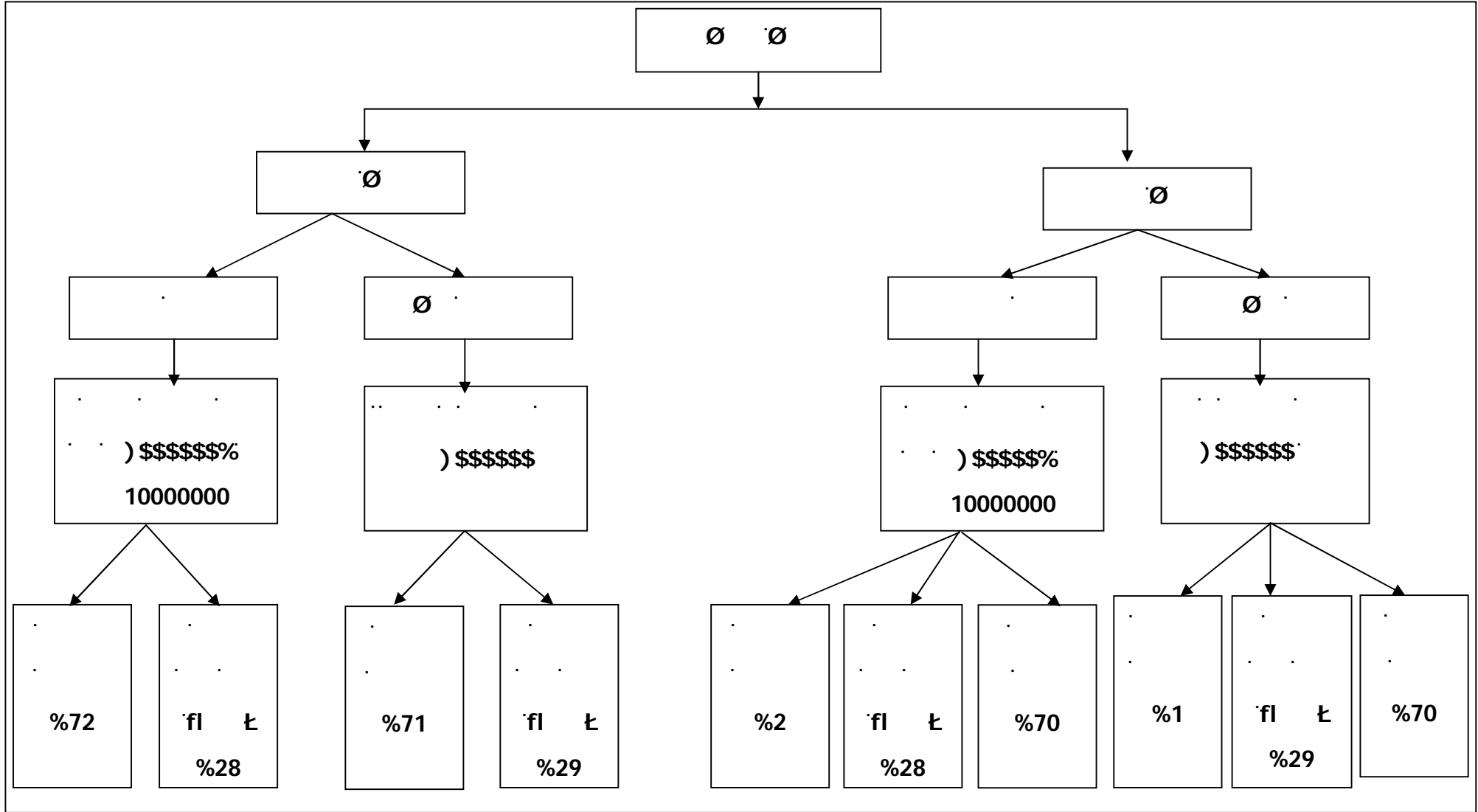



Ù . . . . . Ù

Ù . . . . . Ù

(1) Ù

Ù .1

Ù . . . . . Ù

Ù . . . . . Ù

%\$

"1

!

fi ) \$\$\$\$LÕ

•

"1

Ù ( ) \$\$\$\$) Õ

•

fi %\$\$\$\$\$L

•

Ù

Ù

"

Ù

"

Ù

Ù

.Ø .2

Ù "

1

Ù

-

1

-

1

-

Ù . . . . . Ù (1)



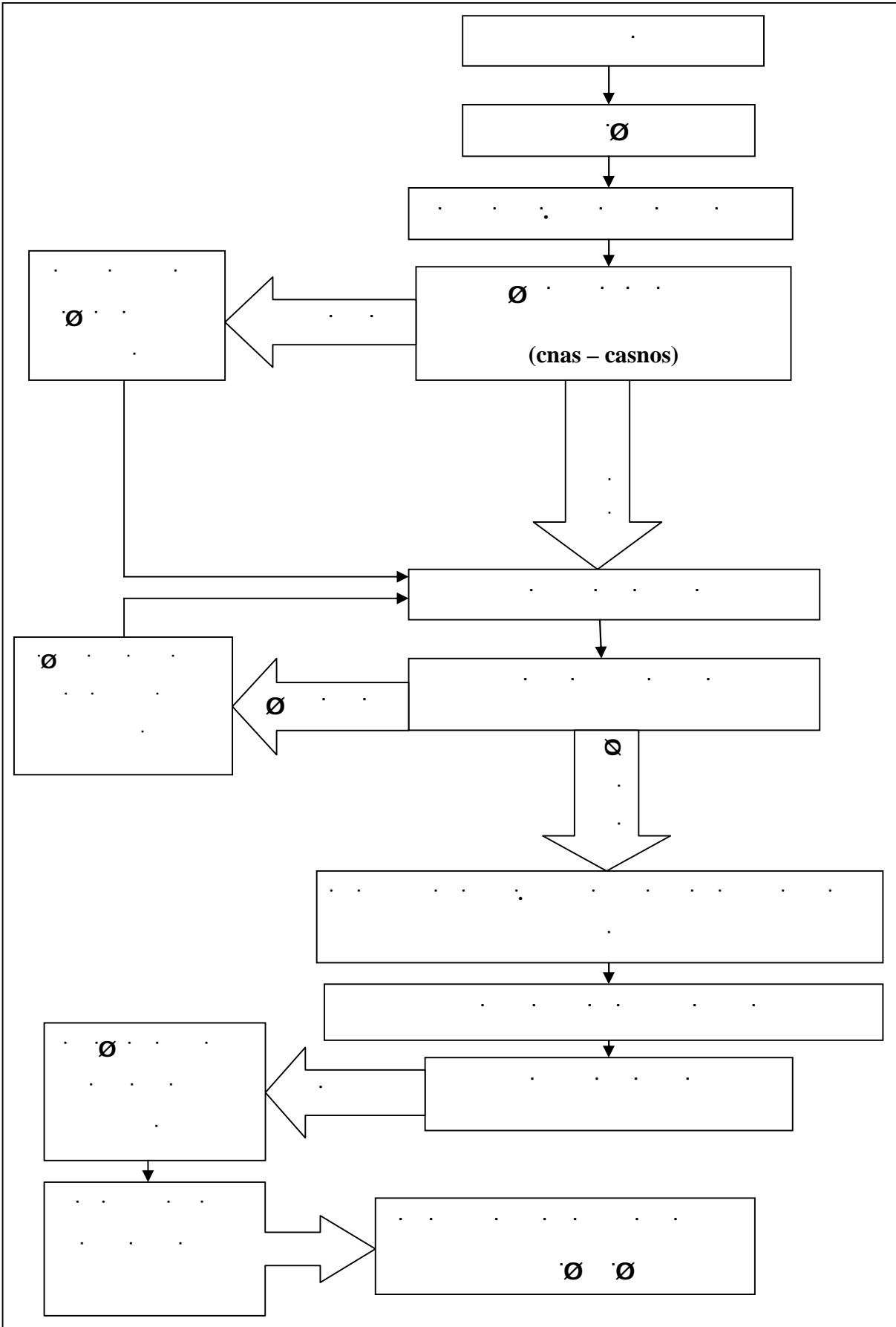

! ···· Ø ····

Ù ···· Ù ····  
! ····  
fl ···· ÈVAN ····  
Ù ····

Ø ····

Ù ····  
Ù ···· Ù ····  
"f\$ ···· È ····  
Ù ····

Ù ····  
Ù ···· " ···· Ù ···· Ù ····  
"f\$( ···· È ····

Ù ····  
È ···· Ù ···· Ù ····  
"f\$( ···· È "f&% ···· Ù ···· Ù ····

"f\$) ···· È ···· Ù ····  
Ù ····

"f\$\* ···· È ···· Ù ····  
Ù ····

Ø ····

È ···· Ù ····  
Ù ···· Ù ···· f\$+  
Ù ···· ÈVANÈ ····  
" ···· Ù ····

Ù ····  
Ù ···· Ù ····  
Ù ····

	0	1	2	3	4	5	6	7	8	9	0
0	0	1	2	3	4	5	6	7	8	9	0
1	1	2	3	4	5	6	7	8	9	0	1
2	2	3	4	5	6	7	8	9	0	1	2
3	3	4	5	6	7	8	9	0	1	2	3
4	4	5	6	7	8	9	0	1	2	3	4
5	5	6	7	8	9	0	1	2	3	4	5
6	6	7	8	9	0	1	2	3	4	5	6
7	7	8	9	0	1	2	3	4	5	6	7
8	8	9	0	1	2	3	4	5	6	7	8
9	9	0	1	2	3	4	5	6	7	8	9
0	0	1	2	3	4	5	6	7	8	9	0







\_\_\_\_\_ .2

õ õ

õ õ

õ õ ù

õ õ ù

õ õ ù

õ õ ù

õ õ ù

õ õ ù

õ õ ù

õ õ ù

õ õ ù

õ õ ù

õ õ ù

õ õ ù

õ õ ù

õ õ ù

õ õ ù

õ õ ù

õ õ ù

õ õ ù





Ù

Ù

Ù

Ù

Ù

Ù

Ù

Ù

Õ Õ Õ Õ Ù

Ù

Ù

Õ

Ù

Ù

Õ

Ù

(ANSEJ)

Ù

Ù

Ù

Ù

Õ

Õ

Õ

Ù

Ù

Ù

Ù

Ø

Õ

Ù

Ù

Õ

Ù

Õ

(ANSEJ)

Ù

Ù

Õ

Ù

Õ

Ù

Õ

Õ

Õ

(Adelsoft)

(sofy)

Õ

Õ

Õ

Õ

Ù

Ù

Ù

Ù

Ù

Ù

Ù

Ù

Ù

Ù

Ù

Ù

Ù

Ù

Ù

Ù

Ù

Ù

Ù

Ù

Ø

õ ùõ

Ù

õ õ

õ õ

ùõ

õ õ fl %\$\$\$\$\$\$L

Ù

fl +\$\$\$\$\$\$L

Ù

õ õ

Ù

"" Ù

Ù

Ø

Ù

Ù

Ù

Ù

""

... .. ù .. .. .. .. .. ù  

---

 .. .. ù .. ù .. .. .. .. .. ù .. .. .. ..  
 .. .. .. .. .. (Adelsoft) .. .. (sofy) .. ..  
 .. .. .. .. .. ù .. .. .. .. ..  
 \* .. .. .. .. .. ù .. .. .. .. ..  
 .. .. .. .. .. .. .. .. .. .. ..  
 .. .. .. .. .. ù .. .. .. .. ..  
 ù .. ù .. ù .. .. .. .. .. ù .. ù .. ..  
 .. .. .. .. .. ù .. .. .. .. ..  
 .. .. .. .. .. .. .. .. .. .. ..  
 .. .. .. .. .. ù .. ù .. .. ..  
 .. .. .. .. .. f\$) £ f\$ £ .. .. .. .. ..  
 "" .. .. .. .. ..  
 .. .. ù .. .. .. .. ..  
 ò ò .. ù .. .. .. .. .. ù .. .. .. .. ..  
 .. .. .. .. .. ""

.. .. .. .. ..	.. .. .. .. ..
.. .. .. .. .. + ù	.. .. .. .. ..
+ ( .. .. 2 .. 2) ù 4	.. .. .. .. .. (Adelsoft)
.. .. .. .. ..	.. .. .. .. ..
.. .. .. .. .. + ù 5	.. .. .. .. ..
.. .. .. .. .. + ù 4	.. .. .. .. ..
.. .. .. .. .. + .. .. .. .. ù 15	.. .. .. .. .. (Mille gouts)
.. .. .. .. .. + á 4	.. .. .. .. ..
.. .. .. .. .. + ù 4	.. .. .. .. ..

... .. ù ... .. . ù  



---

 ) ( ù ù  
 %  
 ù ù  
 ù ù  
 ù ù  
 ù ù

..Ø

Õ Ù Ù  
Õ Ù ! ! Ù  
Õ Ù Ù  
..  
..1  
Õ Ù Ù  
Õ Ù Õ Õ Õ Õ Õ Õ  
Ù Ù Ù Ù Ù Ù Ù Ù  
1  
Õ Õ Õ Õ Õ Ù  
Õ Õ Ù Ù Ù Ù  
1  
Ù  
Õ Õ Õ Ù

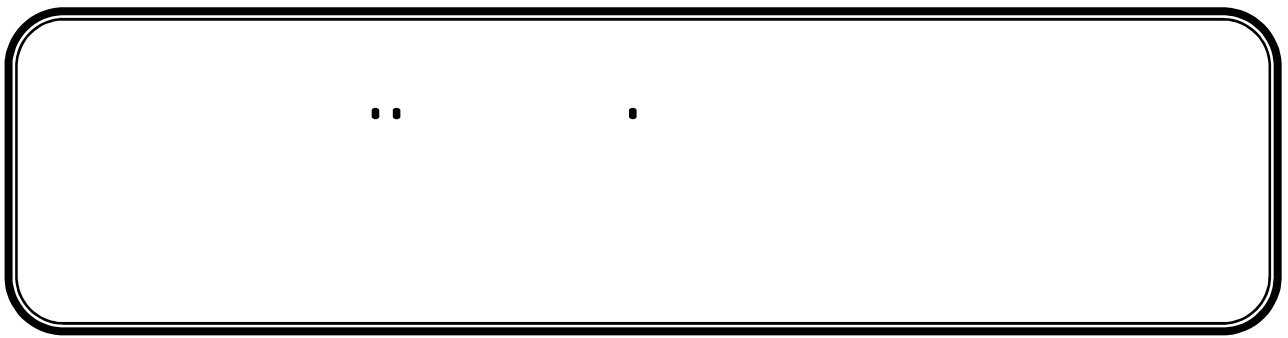
.(SOFY) (ADELSOFT)













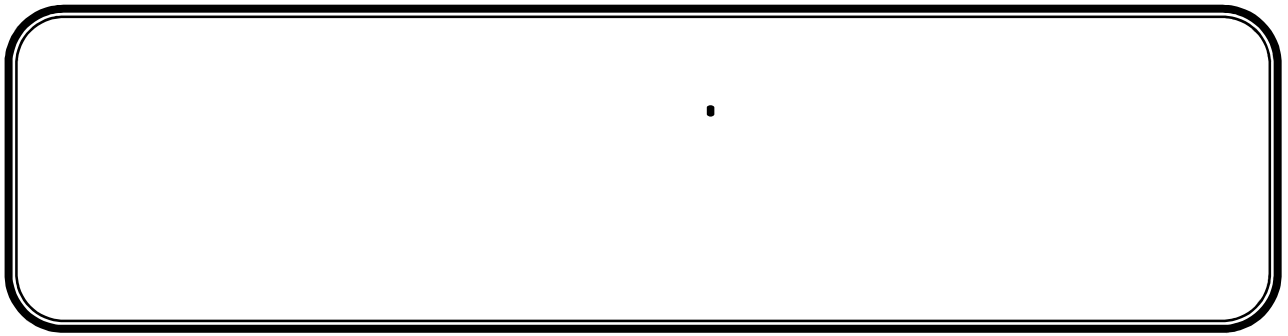



.. . . :

.. ∞∞∞ "

.....  
\_\_\_\_\_ .1

"&\$\$-

.....  
\_\_\_\_\_ .2

"&\$\$-

.....  
\_\_\_\_\_ .3

"&\$%\$

.....  
\_\_\_\_\_ .4

"&\$%&

( .....  
\_\_\_\_\_ .5

.2010

" .....  
\_\_\_\_\_ .6

.....  
\_\_\_\_\_ .7

"&\$%\$

.....  
\_\_\_\_\_ .8

"&\$%\$

.....  
\_\_\_\_\_ .9

.2010

.....  
\_\_\_\_\_ .10

"&\$%\$

.....  
\_\_\_\_\_ .11

"&\$\$,

.....  
\_\_\_\_\_ .12

.2011

.....

---

"&\$%&'	.....	.13
.....	.....	Ù .14
		.2008
.....	.....	.15
	"&\$\$*'	
Ù	.....	Ù .16
	"&\$\$('	
.....	.....	.17
	"&\$%&'	&
.....	.....	.18
		.2008
.....	Ù	.19
	"&\$%&'	
"&\$\$*'	.....	.20
.....	.....	.21
		.2009
.....	.....	.22
	"&\$%'	
.....	.....	.23
	"&\$%\$'	
Ù	.....	.24
	"&\$\$-	
.....	.....	.25
	"&\$%\$'	

.....

---

Ù	.26
	.2012
"&\$%&'	.27
	"
" +'	Ù .1
	.2
"&\$%\$ +'	
	"
i	Ù .1
"&\$%&Ù % %	
	Ø "
	.1
"&\$% ' Ù	
	.2
"&\$%\$&'	
	.3
"&\$%\$* Ù	
Ù	.4
Ù	
"&\$% ' Ù	"&\$% Ù
	.5
"&\$% ' Ù	
	.6
	"&\$% ( ' Ù



.. . . : Ô  
" "

1. GAUTIER Bourdeaux, Gestion de la Banque, publié par Dunod, Paris, 6<sup>e</sup> édition, 2010.
2. MISHKIN Frederic, Monnaie, banque et marchés financiers, publié par Pearson éducation, paris, 9<sup>e</sup> édition, 2010.

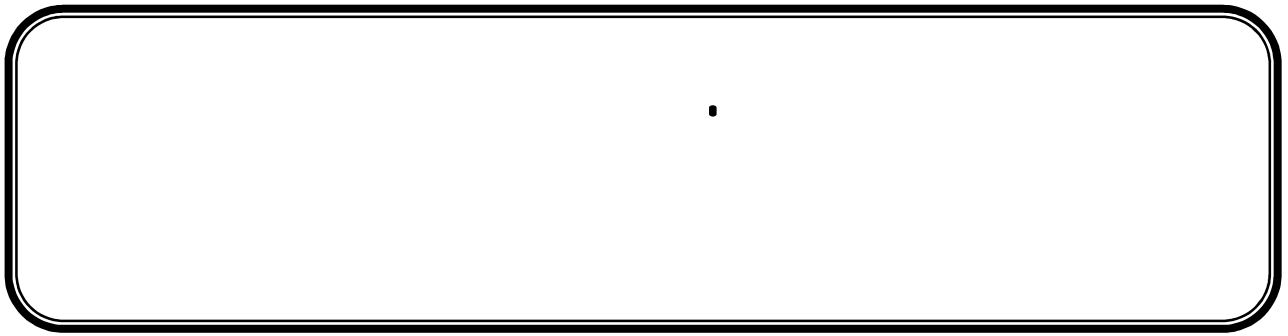

(ANSEJ) Ô ••••• Ø •••••

•Û •Û •••••

•! •! •Û •••••

◦ ••••• •Û ••••• •Û .1

••••• •Û ••••• •Û .2

◦Û •••••

◦ ••••• •Û ••••• .3

•Û •Û •Û •Û •Û •Û •Û •Û •Û .4

◦Û •••••

◦ •Û ••••• •Û ••••• fl •Û •Û .5

••••• •Û ••••• fl •Û •Û •Û •Û •Û •Û •Û •Û •Û .6

◦Û •••••

••Û ••••• •Û ••••• •Û •Û ••••• •Û .7

◦ •Û •••••

•Û ••••• •Û ••••• •Û •Û •Û ••••• •Û .8

◦

◦ •Û ••••• •Û ••••• •Û •Û ••••• •Û .9

••••• •Û ••••• ••••• •Û ••••• •Û .10

•••••◦Û •••••

••••• •Û ••••• ••••• •Û ••••• •Û .11

◦ •Û •••••



(ANSEJ)

- o . . . . . (1)
- o . . . . . (2)
- o . . . . . (3)
- o . . . . . (4)
- o . . . . . (5)
- o . . . . . (6)
- o . . . . . (7)
- o . . . . . (8)
- o . . . . . (9)
- o . . . . . (10)
- o . . . . . (11)
- o . . . . . (12)
- o . . . . . (13)
- o . . . . . (14)
- o . . . . . (15)
- o . . . . . (16)
- o . . . . . (17)
- o . . . . . (18)

الملحق رقم (3هـ) : مرحلة إعداد مخطط الأعمال

الجمهورية الجزائرية الديمقراطية الشعبية  
République Algérienne Démocratique et Populaire

Ministère du Travail, de l'Emploi  
et de la Sécurité Sociale  
Agence Nationale de Soutien  
à l'Emploi des Jeunes  
ANSEJ



الوكالة الوطنية  
للدعم وتشغيل الشباب  
ANSEJ

وزارة العمل والتشغيل  
والضمان الإجتماعي  
الوكالة الوطنية لدعم  
تشغيل الشباب

PLAN D'AFFAIRES PHASE CREATION

DATE D'ETABLISSEMENT DU PLAN D'AFFAIRES	00-01-1900	DATE DE DEPOT DU DOSSIER	00-01-1900
ANTENNE DE:	0	ANNEXE DE:	0
N° DOSSIER (siej3)	0	NOMENCLATURE CNRC	CODE
INITITULE DU PROJET :	0		0
FORME JURIDIQUE:	PERSONNE PHYSIQUE	NOM/RAISON SOCIALE	0
SECTEUR D'ACTIVITE :	SERVICES		
SECTEUR PRIORITAIRE	0	ZONE PRIORITAIRE	0
		TYPE DE FINANCEMENT	TRIANGULAIRE

Prénom et nom de l'accompagnateur:



الوكالة الوطنية  
للدعم وتشغيل الشباب  
ANSEJ

الجمهورية الجزائرية الديمقراطية الشعبية  
وزارة العمل والتشغيل والضمان الاجتماعي  
الوكالة الوطنية لدعم تشغيل الشباب

PLAN D'AFFAIRES PHASE CREATION

# الملحق رقم (04): الدراسة المالية للمشروع الممولة من طرف الوكالة

الجمهورية الجزائرية الديمقراطية الشعبية  
République Algérienne Démocratique et Populaire



Ministère du Travail, de l'Emploi  
et de la Sécurité Sociale

Agence Nationale de Soutien  
à l'Emploi des Jeunes  
ANSEJ

وزارة العمل و التوظيف  
و الضمان الإجتماعي

الوكالة الوطنية لدعم  
توظيف الشباب

Zone :

1

\* Zone 1 : Zone normale

\* Zone 2 : Zone à promouvoir

Type de financement:

1

\*Triangulaire

1

\*Mixte

2

## (D) ETUDE FINANCIERE

### (D.1) Structure de l'investissement:

(en DA)

Rubrique	Coût	Coût TOTAL
Frais de la location	0.00	0.00
Frais préliminaires	0.00	0.00
Cotisation fonds de garantie	0.00	
Assurances		
Autres frais	0.00	
Equipements de production	0.00	0.00
Equipements locaux	0.00	
Equipements importés	0.00	
Cheptel	0.00	0.00
Materiels roulants	0.00	0.00
Aménagements	0.00	0.00
Outillages	0.00	0.00
Mobilier de bureau	0.00	0.00
Materiels informatiques	0.00	0.00
Droit de douanes et taxes	0.00	0.00
Autres impôts et taxes	0.00	0.00
Frais d'installation	0.00	0.00
Frais de transport	0.00	
Montage et essais	0.00	
Fonds de roulement	0.00	0.00
Autres1	0.00	0.00
Autres2	0.00	0.00
TOTAL	0.00	0.00

N°Dossier : 0

Raison sociale 0

Gérant :

Activité : 0

Montant des équipements importés en DA	Cours de conversion relevé le		Droit de douanes	
	Montant Equip	Cours Devise en DA	Montant en DA	Taux
	0.00	0.00	0.00	0%

### (D.2) Structure de Financement:

Rubrique	Taux Particip	Montant
Apport personnel	1%	0.00
Numéraires		0.00
Nature		0.00
PNR Classique	29%	0.00
PNR LO		0.00
PNR VA		0.00
Crédit Bancaire	70%	0.00
TOTAL	100%	0.00

### (D.3) Tableau d'amortissement du crédit Bancaire:

Montant du crédit	0.00							
Durée du crédit	8.00							
Taux d'intérêt bancaire	5.5%							
Taux de bonification	100%							
Taux d'intérêt réel	0.00%							
Rubrique	ANNEE 1	ANNEE 2	ANNEE 3	ANNEE 4	ANNEE 5	ANNEE 6	ANNEE 7	Année 8
Principal	0.00	0.00	0.00	0.00	0.00	0.00	0.00	0.00
Reste à rembourser ( encours)	0.00	0.00	0.00	0.00	0.00	0.00	0.00	0.00
Intérêts Bancaires bonifiés	0.00	0.00	0.00	0.00	0.00	0.00	0.00	0.00
Cotisation au FG	0.00	0.00	0.00	0.00	0.00	0.00	0.00	0.00
Cotisation à verser	0.00							

الملحق رقم (05): الميزانية الافتتاحية.

N°Dossier :	0
Raison sociale	0
Nom et Prénom du Gérant :	
Activité :	0

(D.4) BILAN D'OUVERTURE

ACTIF	MONTANT	PASSIF	MONTANT
		<b>1- FONDS PROPRES</b>	0.00
<b>2- INVESTISSEMENT</b>			
Frais Préliminaires	0.00		
Equipements de production	0.00		
Outils	0.00		
Materiel Roulant	0.00		
Matriels de bureau	0.00		
Materiels informatiques	0.00		
Aménagement	0.00		
Autres	0.00		
<b>3- STOCKS</b>			
Matieres et Fournit	0.00		
<b>4- CREANCES</b>		<b>5- DETTES D'INVESTISSEMENT</b>	
Caisse et banque	0.00	Emprunts bancaires(CMT)	0.00
Frais de la location	0.00	Autres emprunts (PNR Classique)	0.00
		Autres emprunts (PNR LO)	0.00
		Autres emprunts (PNR VA)	0.00
<b>TOTAL</b>	0.00	<b>TOTAL</b>	0.00

# الملاحق رقم (06): الميزانية التقديرية

N° Dossier : 0  
 Balance sociale : 0  
 Nom et Prénom de créant :  
 Activité : 0

N° Dossier : 0  
 Balance sociale : 0  
 Nom et Prénom de créant :  
 Activité : 0

	1er année			2ème année			3ème année			4ème année			5ème année			6ème année			7ème année			8ème année		
	BRUT	AMORTI	NET	BRUT	AMORTI	NET	BRUT	AMORTI	NET	BRUT	AMORTI	NET	BRUT	AMORTI	NET	BRUT	AMORTI	NET	BRUT	AMORTI	NET	BRUT	AMORTI	NET
<b>2-INVESTISSEMENTS</b>	0.00	0.00	0.00	0.00	0.00	0.00	0.00	0.00	0.00	0.00	0.00	0.00	0.00	0.00	0.00	0.00	0.00	0.00	0.00	0.00	0.00	0.00	0.00	0.00
Frais Préliminaires	0.00	0.00	0.00	0.00	0.00	0.00	0.00	0.00	0.00	0.00	0.00	0.00	0.00	0.00	0.00	0.00	0.00	0.00	0.00	0.00	0.00	0.00	0.00	0.00
Equipements de Prod	0.00	0.00	0.00	0.00	0.00	0.00	0.00	0.00	0.00	0.00	0.00	0.00	0.00	0.00	0.00	0.00	0.00	0.00	0.00	0.00	0.00	0.00	0.00	0.00
Cheriel	0.00	0.00	0.00	0.00	0.00	0.00	0.00	0.00	0.00	0.00	0.00	0.00	0.00	0.00	0.00	0.00	0.00	0.00	0.00	0.00	0.00	0.00	0.00	0.00
Outils	0.00	0.00	0.00	0.00	0.00	0.00	0.00	0.00	0.00	0.00	0.00	0.00	0.00	0.00	0.00	0.00	0.00	0.00	0.00	0.00	0.00	0.00	0.00	0.00
Equipements Roulant	0.00	0.00	0.00	0.00	0.00	0.00	0.00	0.00	0.00	0.00	0.00	0.00	0.00	0.00	0.00	0.00	0.00	0.00	0.00	0.00	0.00	0.00	0.00	0.00
Matériel de bureau	0.00	0.00	0.00	0.00	0.00	0.00	0.00	0.00	0.00	0.00	0.00	0.00	0.00	0.00	0.00	0.00	0.00	0.00	0.00	0.00	0.00	0.00	0.00	0.00
Matériel Informatique	0.00	0.00	0.00	0.00	0.00	0.00	0.00	0.00	0.00	0.00	0.00	0.00	0.00	0.00	0.00	0.00	0.00	0.00	0.00	0.00	0.00	0.00	0.00	0.00
Aménagement	0.00	0.00	0.00	0.00	0.00	0.00	0.00	0.00	0.00	0.00	0.00	0.00	0.00	0.00	0.00	0.00	0.00	0.00	0.00	0.00	0.00	0.00	0.00	0.00
Autres	0.00	0.00	0.00	0.00	0.00	0.00	0.00	0.00	0.00	0.00	0.00	0.00	0.00	0.00	0.00	0.00	0.00	0.00	0.00	0.00	0.00	0.00	0.00	0.00
<b>3-STOCKS</b>																								
Matières et Fournit																								
<b>4-CREANCES</b>																								
la caisse																								
Banque																								
Frais de location																								
<b>TOTAL</b>																								
<b>PASSIF</b>																								
<b>1-FONDS PROPRES</b>																								
Resultat en fin d'exercice																								
<b>5- DETTES D'INVESTISSEMENTS</b>																								
Emprunts bancaires																								
Autres emprunts (ANSEJ)																								
Dettes fournisseurs																								
Dettes à court terme																								
Dettes d'exploitation																								
<b>RÉSULTATS</b>																								
<b>TOTAL</b>																								

الملاحق رقم (07) جدول حسابات النتائج

N° Dossier :	0
Raison sociale	0
Nom et Prénom du Gérant :	
Activité :	0

	ANNEE 1	ANNEE 2	ANNEE 3	ANNEE 4	ANNEE 5	ANNEE 6	ANNEE 7	ANNEE 8
<b>(D.5) TCR PREVISIONNELS</b>								
Ventes marchandises								
Marchandises consommées								
Marge brute	0.00	0.00	0.00	0.00	0.00	0.00	0.00	0.00
Production vendue	0.00	0.00	0.00	0.00	0.00	0.00	0.00	0.00
Prestations fournies	0.00	0.00	0.00	0.00	0.00	0.00	0.00	0.00
Matière et fournitures consomm.,	0.00	0.00	0.00	0.00	0.00	0.00	0.00	0.00
Services	90,000.00	93,600.00	97,344.00	101,237.76	105,287.27	109,498.76	113,878.71	118,433.86
Transport	20,000.00	20,800.00	21,632.00	22,497.28	23,397.17	24,333.06	25,306.38	26,318.64
Loyers charges locatives	60,000.00	62,400.00	64,896.00	67,491.84	70,191.51	72,999.17	75,919.14	78,955.91
Entretien et réparation	10,000.00	10,400.00	10,816.00	11,248.64	11,698.59	12,166.53	12,653.19	13,159.32
Autres services	0.00	0.00	0.00	0.00	0.00	0.00	0.00	0.00
<b>Valeur ajoutée</b>	<b>-90,000.00</b>	<b>-93,600.00</b>	<b>-97,344.00</b>	<b>-101,237.76</b>	<b>-105,287.27</b>	<b>-109,498.76</b>	<b>-113,878.71</b>	<b>-118,433.86</b>
Frais de personnel	907,200.00	925,344.00	943,850.88	962,727.90	981,982.46	1,001,622.10	1,021,654.55	1,042,087.64
Frais divers	#VALEURI	#VALEURI	#VALEURI	#VALEURI	#VALEURI	#VALEURI	#VALEURI	#VALEURI
Assurances	#VALEURI	#VALEURI	#VALEURI	#VALEURI	#VALEURI	#VALEURI	#VALEURI	#VALEURI
Autres frais	43,524.20	23,524.20	23,524.20	23,524.20	18,819.36	14,114.52	9,409.68	4,704.84
Droit de douanes	0.00	0.00	0.00	0.00	0.00	0.00	0.00	0.00
Amortissements	1,870,053.04	1,870,053.04	1,870,053.04	1,870,053.04	1,870,053.04	1,870,053.04	1,870,053.04	1,870,053.04
<b>Charges d'exploitation</b>	<b>#VALEURI</b>	<b>#VALEURI</b>	<b>#VALEURI</b>	<b>#VALEURI</b>	<b>#VALEURI</b>	<b>#VALEURI</b>	<b>#VALEURI</b>	<b>#VALEURI</b>
<b>RBE</b>	<b>#VALEURI</b>	<b>#VALEURI</b>	<b>#VALEURI</b>	<b>#VALEURI</b>	<b>#VALEURI</b>	<b>#VALEURI</b>	<b>#VALEURI</b>	<b>#VALEURI</b>
IFU	0.00	0.00	0.00	0.00	0.00	0.00	0.00	0.00
<b>R.net d'exploitation</b>	<b>#VALEURI</b>	<b>#VALEURI</b>	<b>#VALEURI</b>	<b>#VALEURI</b>	<b>#VALEURI</b>	<b>#VALEURI</b>	<b>#VALEURI</b>	<b>#VALEURI</b>
Cash flow net	#VALEURI	#VALEURI	#VALEURI	#VALEURI	#VALEURI	#VALEURI	#VALEURI	#VALEURI
Cash flow cumulés	#VALEURI	#VALEURI	#VALEURI	#VALEURI	#VALEURI	#VALEURI	#VALEURI	#VALEURI
Cash flow actualisés	#VALEURI	#VALEURI	#VALEURI	#VALEURI	#VALEURI	#VALEURI	#VALEURI	#VALEURI
<b>VAN</b>	<b>#VALEURI</b>	<b>#VALEURI</b>	<b>#VALEURI</b>	<b>#VALEURI</b>	<b>#VALEURI</b>	<b>#VALEURI</b>	<b>#VALEURI</b>	<b>#VALEURI</b>